



**NONRESIDENT
TRAINING
COURSE**



April 1999

Aerographer's Mate

Module 4—Environmental Communications and Administration

NAVEDTRA 14272

Although the words “he,” “him,” and “his” are used sparingly in this course to enhance communication, they are not intended to be gender driven or to affront or discriminate against anyone.

PREFACE

By enrolling in this self-study course, you have demonstrated a desire to improve yourself and the Navy. Remember, however, this self-study course is only one part of the total Navy training program. Practical experience, schools, selected reading, and your desire to succeed are also necessary to successfully round out a fully meaningful training program.

THE COURSE: This self-study course is organized into subject matter areas, each containing learning objectives to help you determine what you should learn along with text and illustrations to help you understand the information. The subject matter reflects day-to-day requirements and experiences of personnel in the rating or skill area. It also reflects guidance provided by Enlisted Community Managers (ECMs) and other senior personnel, technical references, instructions, etc., and either the occupational or naval standards, which are listed in the *Manual of Navy Enlisted Manpower Personnel Classifications and Occupational Standards*, NAVPERS 18068.

THE QUESTIONS: The questions that appear in this course are designed to help you understand the material in the text.

VALUE: In completing this course, you will improve your military and professional knowledge. Importantly, it can also help you study for the Navy-wide advancement in rate examination. If you are studying and discover a reference in the text to another publication for further information, look it up.

*1999 Edition Prepared by
AGC(SW) Stephen M. Volpe
AGC(AW) Kristopher W. Blom*

Published by
NAVAL EDUCATION AND TRAINING
PROFESSIONAL DEVELOPMENT
AND TECHNOLOGY CENTER

**NAVSUP Logistics Tracking Number
0504-LP-026-9030**

Sailor's Creed

“I am a United States Sailor.

I will support and defend the Constitution of the United States of America and I will obey the orders of those appointed over me.

I represent the fighting spirit of the Navy and those who have gone before me to defend freedom and democracy around the world.

I proudly serve my country's Navy combat team with honor, courage and commitment.

I am committed to excellence and the fair treatment of all.”

CONTENTS

CHAPTER	Page
1. Environmental Communications	1-1
2. Environmental Software Programs.	2-1
3. Administration	3-1
APPENDIX	
I. Glossary.	AI-1
II. MANOP Codes.	AII-1
III. Reference List.	AIII-1
INDEX	INDEX-1

Nonresident Training Course Follows The Index

SUMMARY OF THE AEROGRAPHER'S MATE TRAINING SERIES

The following modules of the AG training series are available:

AG MODULE 1, NAVEDTRA 14269, *Surface Weather Observations*

This module covers the basic procedures that are involved with conducting surface weather observations. It begins with a discussion of surface observation elements, followed by a description of primary and backup observation equipment that is used aboard ships and at shore stations. Module 1 also includes a complete explanation of how to record and encode surface METAR observations using WMO and NAVMETOCCOM guidelines. The module concludes with a description of WMO plotting models and procedures.

AG MODULE 2, NAVEDTRA 14270, *Miscellaneous Observations and Codes*

This module concentrates on the observation procedures, equipment, and codes associated with upper-air observations and bathythermograph observations. Module 2 also discusses aviation weather codes, such as TAFs and PIREPs, and includes a chapter on surf observation procedures. Radiological fallout and chemical contamination plotting procedures are also explained.

AG MODULE 3, NAVEDTRA 14271, *Environmental Satellites and Weather Radar*

This module describes the various type of environmental satellites, satellite imagery, and associated terminology. It also discusses satellite receiving equipment. In addition, Module 3 contains information on the Weather Surveillance Radar-1988 Doppler (WSR-88D). It includes a discussion of electromagnetic energy and radar propagation theory, and explains the basic principles of Doppler radar. The module also describes the configuration and operation of the WSR-88D, as well as WSR-88D products.

AG MODULE 4, NAVEDTRA 14272, *Environmental Communications and Administration*

This module covers several of the most widely used environmental communications systems within the METOC community. It also describes the software programs and products associated with these systems. The module concludes with a discussion of basic administration procedures.

NOTE

Additional modules of the AG training series are in development. Check the NETPDTC website for details at <http://www.cnet.navy.mil/netpdtc/nac/neas.htm>. For ordering information, check NAVEDTRA 12061, Catalog of Nonresident Training Courses, which is also available on the NETPDTC website.

SAFETY PRECAUTIONS

Safety is a paramount concern for all personnel. Many of the Naval Ship's Technical Manuals, manufacturer's technical manuals, and every Planned Maintenance System (PMS) maintenance requirement card (MRC) include safety precautions. Additionally, OPNAVINST 5100.19 (series), *Naval Occupational Safety and Health (NAVOSH) Program Manual for Forces Afloat*, and OPNAVINST 5100.23 (series), *NAVOSH Program Manual*, provide safety and occupational health information. The safety precautions are for your protection and to protect equipment.

During equipment operation and preventive or corrective maintenance, the procedures may call for personal protective equipment (PPE), such as goggles, gloves, safety shoes, hard hats, hearing protection, and respirators. When specified, your use of PPE is mandatory. You must select PPE appropriate for the job since the equipment is manufactured and approved for different levels of protection. If the procedure does not specify the PPE, and you aren't sure, ask your safety officer.

Most machinery, spaces, and tools requiring you to wear hearing protection are posted with hazardous noise signs or labels. Eye hazardous areas requiring you to wear goggles or safety glasses are also posted. In areas where corrosive chemicals are mixed or used, an emergency eyewash station must be installed.

All lubricating agents, oil, cleaning material, and chemicals used in maintenance and repair are hazardous materials. Examples of hazardous materials are gasoline, coal distillates, and asphalt. Gasoline contains a small amount of lead and other toxic compounds. Ingestion of gasoline can cause lead poisoning. Coal distillates, such as benzene or naphthalene in benzol, are suspected carcinogens. Avoid all skin contact and do not inhale the vapors and gases from these distillates. Asphalt contains components suspected of causing cancer. Anyone handling asphalt must be trained to handle it in a safe manner.

Hazardous materials require careful handling, storage, and disposal. PMS documentation provides hazard warnings or refers the maintenance man to the Hazardous Materials User's Guide. Material Safety Data Sheets (MSDS) also provide safety precautions for hazardous materials. All commands are required to have an MSDS for each hazardous material they have in their inventory. You must be familiar with the dangers associated with the hazardous materials you use in your work. Additional information is available from your command's *Hazardous Material Coordinator*. OPNAVINST 4110.2 (series), *Hazardous Material Control and Management*, contains detailed information on the hazardous material program.

Recent legislation and updated Navy directives implemented tighter constraints on environmental pollution and hazardous waste disposal. OPNAVINST 5090.1 (series), *Environmental and Natural Resources Program Manual*, provides detailed information. Your command must comply with federal, state, and local environmental regulations during any type of construction and demolition. Your supervisor will provide training on environmental compliance.

Cautions and warnings of potentially hazardous situations or conditions are highlighted, where needed, in each chapter of this TRAMAN. Remember to be safety conscious at all times.

INSTRUCTIONS FOR TAKING THE COURSE

ASSIGNMENTS

The text pages that you are to study are listed at the beginning of each assignment. Study these pages carefully before attempting to answer the questions. Pay close attention to tables and illustrations and read the learning objectives. The learning objectives state what you should be able to do after studying the material. Answering the questions correctly helps you accomplish the objectives.

SELECTING YOUR ANSWERS

Read each question carefully, then select the BEST answer. You may refer freely to the text. The answers must be the result of your own work and decisions. You are prohibited from referring to or copying the answers of others and from giving answers to anyone else taking the course.

SUBMITTING YOUR ASSIGNMENTS

To have your assignments graded, you must be enrolled in the course with the Nonresident Training Course Administration Branch at the Naval Education and Training Professional Development and Technology Center (NETPDTC). Following enrollment, there are two ways of having your assignments graded: (1) use the Internet to submit your assignments as you complete them, or (2) send all the assignments at one time by mail to NETPDTC.

Grading on the Internet: Advantages to Internet grading are:

- you may submit your answers as soon as you complete an assignment, and
- you get your results faster; usually by the next working day (approximately 24 hours).

In addition to receiving grade results for each assignment, you will receive course completion confirmation once you have completed all the

assignments. To submit your assignment answers via the Internet, go to:

<http://courses.cnet.navy.mil>

Grading by Mail: When you submit answer sheets by mail, send all of your assignments at one time. Do NOT submit individual answer sheets for grading. Mail all of your assignments in an envelope, which you either provide yourself or obtain from your nearest Educational Services Officer (ESO). Submit answer sheets to:

COMMANDING OFFICER
NETPDTC N331
6490 SAUFLEY FIELD ROAD
PENSACOLA FL 32559-5000

Answer Sheets: All courses include one “scannable” answer sheet for each assignment. These answer sheets are preprinted with your SSN, name, assignment number, and course number. Explanations for completing the answer sheets are on the answer sheet.

Do not use answer sheet reproductions: Use only the original answer sheets that we provide—reproductions will not work with our scanning equipment and cannot be processed.

Follow the instructions for marking your answers on the answer sheet. Be sure that blocks 1, 2, and 3 are filled in correctly. This information is necessary for your course to be properly processed and for you to receive credit for your work.

COMPLETION TIME

Courses must be completed within 12 months from the date of enrollment. This includes time required to resubmit failed assignments.

PASS/FAIL ASSIGNMENT PROCEDURES

If your overall course score is 3.2 or higher, you will pass the course and will not be required to resubmit assignments. Once your assignments have been graded you will receive course completion confirmation.

If you receive less than a 3.2 on any assignment and your overall course score is below 3.2, you will be given the opportunity to resubmit failed assignments. **You may resubmit failed assignments only once.** Internet students will receive notification when they have failed an assignment--they may then resubmit failed assignments on the web site. Internet students may view and print results for failed assignments from the web site. Students who submit by mail will receive a failing result letter and a new answer sheet for resubmission of each failed assignment.

COMPLETION CONFIRMATION

After successfully completing this course, you will receive a letter of completion.

ERRATA

Errata are used to correct minor errors or delete obsolete information in a course. Errata may also be used to provide instructions to the student. If a course has an errata, it will be included as the first page(s) after the front cover. Errata for all courses can be accessed and viewed/downloaded at:

<http://www.cnet.navy.mil/netpdtc/nac/neas.htm>

STUDENT FEEDBACK QUESTIONS

We value your suggestions, questions, and criticisms on our courses. If you would like to communicate with us regarding this course, we encourage you, if possible, to use e-mail. If you write or fax, please use a copy of the Student Comment form that follows this page.

For subject matter questions:

E-mail: n315.products@cnet.navy.mil
Phone: Comm: (850) 452-1001, Ext. 1713
DSN: 922-1001, Ext. 1713
FAX: (850) 452-1370
(Do not fax answer sheets.)
Address: COMMANDING OFFICER
NETPDTC (CODE N315)
6490 SAUFLEY FIELD ROAD
PENSACOLA FL 32509-5000

For enrollment, shipping, grading, or completion letter questions

E-mail: fleetservices@cnet.navy.mil
Phone: Toll Free: 877-264-8583
Comm: (850) 452-1511/1181/1859
DSN: 922-1511/1181/1859
FAX: (850) 452-1370
(Do not fax answer sheets.)
Address: COMMANDING OFFICER
NETPDTC (CODE N331)
6490 SAUFLEY FIELD ROAD
PENSACOLA FL 32559-5000

NAVAL RESERVE RETIREMENT CREDIT

If you are a member of the Naval Reserve, you will receive retirement points if you are authorized to receive them under current directives governing retirement of Naval Reserve personnel. For Naval Reserve retirement, this course is evaluated at 2 points. (Refer to *Administrative Procedures for Naval Reservists on Inactive Duty*, BUPERSINST 1001.39, for more information about retirement points.)

COURSE OBJECTIVES

In completing this nonresident training course, you will demonstrate a knowledge of the subject matter by correctly answering questions on the following subjects: environmental communications, environmental software programs, and administration.

Student Comments

Course Title: *Aerographer's Mate, Module 4—Environmental Communications and Administration*

NAVEDTRA: 14272 **Date:** _____

We need some information about you:

Rate/Rank and Name: _____ SSN: _____ Command/Unit _____

Street Address: _____ City: _____ State/FPO: _____ Zip _____

Your comments, suggestions, etc.:

<p>Privacy Act Statement: Under authority of Title 5, USC 301, information regarding your military status is requested in processing your comments and in preparing a reply. This information will not be divulged without written authorization to anyone other than those within DOD for official use in determining performance.</p>
--

NETPDTC 1550/41 (Rev 4-00)

CHAPTER 1

ENVIRONMENTAL COMMUNICATIONS

INTRODUCTION

In the field of meteorology and oceanography, we depend heavily on information to do our jobs. We must collect raw observation reports and processed data, and both collect and disseminate forecast products. Today, we must rely heavily on computer systems to process information. Your responsibilities as an observer will include processing data received from various communications systems and retrieving environmental data for the forecaster. In addition, you will be asked to compose various types of message reports for transmission to other activities. Most of these tasks involve the use of computers and computer systems.

In this chapter, we begin with a brief discussion about communications security. We then take a look at several environmental communications systems, such as telephone systems, computer networks, and digital facsimile. Next, we discuss environmental computer workstations, naval message transmission networks, and voice radio systems. We complete the chapter with a discussion of environmental communications systems designed specifically for use aboard ship.

COMMUNICATIONS SECURITY

LEARNING OBJECTIVES: Identify the classification markings and special handling markings authorized for naval correspondence and message traffic. Identify the publication that outlines information and personnel security procedures for the Navy.

Environmental information, for the most part, is freely exchanged between countries of the world. Within the Navy and Marine Corps, some environmental information, if released to the wrong person or country, could threaten the defenses of the United States or our allies. This type of information must be classified according to Department of Defense and Department of the Navy security guidelines to prevent its unauthorized disclosure. Information evaluated for its impact on the defense of the United States is defined as either "unclassified" or "classified."

Unclassified information has been evaluated, but disclosure of the information would not effect the security of the country. *Classified* information, if disclosed, could effect national security to some degree. Access restrictions are assigned to protect classified information.

The program to protect sensitive information and to prevent its intentional or inadvertent disclosure to other nations is discussed in depth in OPNAVINST 5510.1, *Department of the Navy Information and Personnel Security Program Regulation*, often called the *Security Manual*. The manual defines three general categories of classified information in increasing order of restriction: Confidential (C), Secret (S), and Top Secret (TS). Additionally, the *Security Manual* provides definitions and guidelines for handling both unclassified and classified information and information with special-handling markings.

The Naval Telecommunications Procedure--Three (NTP 3), Telecommunications Users Manual further explains the use of special-handling markings. Some of the most common include the following:

- *EFTO (Encrypt For Transmission Only)*: Used to identify and protect messages during electrical transmission that do not meet the criteria for classification but have potential value if subjected to analysis.
- *FOUO (For Official Use Only)*: Unclassified material not given a security classification, but for various reasons, may not be discussed or released to the public.
- *NATO RESTRICTED*: Information treated similar to FOUO with access only for official purposes to North Atlantic Treaty Organization (NATO) member nations.
- *ALLIED RESTRICTED*: Information so marked is treated as Confidential information when received by U.S. activities.
- *NOFORN or NF (NOt releasable to FOReign Nationals)*: Classified material that may not be released to any foreign government, foreign national, or non-United States citizen, even if

that person is employed by the U.S. Government.

- *SPECAT (SPEcial CATegory)*: Message traffic associated with a special project or subject, with access and handling limited to only those personnel designated in writing by the commanding officer.
- *LIMDIS (LIMited DIStribution)*: Distribution within the receiving activity is limited only to those personnel with specific access and need-to-know.
- *PERSONAL FOR*: A classified or unclassified message with distribution limited only to the named recipient(s), normally commanding officers or flag officers.
- *WNINTEL*: This is a control marking that denotes "Warning Notice-Sensitive Intelligence Sources or Methods Involved." Classified intelligence so marked must not be disseminated in any manner outside of authorized channels without the permission of the originator.

All classified information or information that requires special handling must be clearly marked. Normally, printed pages are marked at the top and bottom with a stamp or large machine-printed letters. Classified words, subjects, or titles are marked at the end of the subject line in parentheses. Information within each paragraph or section of a narrative is identified with the security classification and special

handling marking at the beginning of each paragraph or section. Figure 1-1 shows an example of these markings.

OPNAVINST 5510.1 also discusses requirements for granting a security clearance for access to classified information. Access to classified information is granted only on a "need-to-know" basis. You will only be granted access to classified information that is necessary to perform your assigned duties.

Within your command, the Security Officer maintains a list of all permanent party and visitor security clearances and levels of access. Classified information may not be discussed with anyone whose clearance and access level cannot be verified.

As we discuss communications systems in the next section, you will see that most of the environmental information is handled and stored on computers and automated systems. The Department of the Navy has instituted a special security program to protect automated information systems. Your activity has an Automatic Data Processing Security Officer (ADPSO) who is responsible for the security of all personal computers (PCs) and PC based data handling, data processing, and communication systems. The ADPSO is also responsible for the security of other ADP systems, such as the Tactical Environmental Support System (TESS). The ADPSO will provide special security training for personnel that use automated systems as well as control access to these systems.

SECRET-NOFORN

Subj: THIS IS AN EXAMPLE OF A CONFIDENTIAL NOFORN SUBJECT (C-NF)

Ref: (a) This is an example of an unclassified reference used in a classified message or other correspondence (U)

(b) This is an example of a confidential reference title (C)

1. (C) This is an example of a confidential paragraph within a narrative.

2. (U) The second paragraph in this example is unclassified. The (U) only precedes a paragraph of unclassified information in a document containing classified information.

3. (S-NF) This is an example of a secret, no forn paragraph. The entire document must be classified equal to the highest classification and strictest special handling markings of any material contained within the document.

S E C R E T - N O F O R N

(SECURITY MARKINGS FOR ILLUSTRATIVE PURPOSES ONLY)

Figure 1-1.—Example of security markings in a Naval message.

REVIEW QUESTIONS

- Q1. Which publication governs security procedures for the United States Navy?
- Q2. What does the special-handling marking "FOUO" indicate?
- Q3. What does the special-handling marking "NOFORN" indicate?

The area of telecommunications is the most rapidly changing aspect of environmental support. Since many changes will continue to occur in the future, the remainder of this chapter will only summarize the basic components of the most widely used communications systems.

TELECOMMUNICATIONS SYSTEMS

LEARNING OBJECTIVES: Identify the various telecommunications equipment and systems used to transfer environmental information. Discuss general procedures used to transfer data on these systems.

Navy and Marine Corps weather personnel will use many different telecommunications systems to exchange environmental information. These systems make use of dedicated landline, radio wave, and satellite communications technology. The following telecommunications systems are discussed in this section:

- Telephone systems
- Computer networks
- Dedicated meteorological communications systems
- Digital facsimile systems

TELEPHONE COMMUNICATIONS SYSTEMS

Commercial telephone systems and the Defense Switched Network (DSN) in military communications, especially in the field of meteorology and oceanography, are the most common forms of communication for official business ashore.

Navy and Marine Corps activities may provide environmental information to any Department of Defense activity. However, there are restrictions on the

type of information that may be provided to other government agencies, private companies, and to the public. Usually, a written request for information must be approved by the commanding officer before any information may be transferred. All non-routine requests for weather forecasts should be referred to the duty forecaster.

When answering the telephone, always speak clearly. In a standard military telephone greeting, first identify your command, then your rank and last name. Then ask, "May I help you, Sir/or Madam?" Your activity may use a slight modification to this greeting. The caller should identify him/herself by name, rank, and command before proceeding with the conversation. Never discuss, or allow the caller to discuss, classified information on a standard telephone. Use telephone conversation memo pads or record sheets to document the details of a telephone conversation.

When placing a telephone call, think about what you want to say before you dial the phone. Organize your thoughts to allow your phone call to be as brief as possible. Unless you are transmitting data, your call should be limited to 10 minutes or less.

Telephone System Access

Normally, you can access the local commercial network, a commercial long-distance network, and the Defense Switched Network (DSN) from the telephone instrument provided with the local base telephone system. Many Navy and Marine Corps stations are supported by a customized telephone system that allows on-base calls to be made by dialing only four- or five-digit numbers. Other networks are accessed by dialing a one- or two-digit access code.

Complete instructions on the use of your local telephone system and how to access other available systems is normally provided in your base telephone book. Your command will also provide additional guidance on the use of the telephone. This guidance is usually found in a station instruction or in your command's standard operating procedures (SOPs).

COMMERCIAL LONG-DISTANCE SERVICE.—Commercial long-distance telephone service is available on all government telephone networks. Your command must pay for all commercial long-distance services. Virtually all military activities require that a long-distance phone call record slip or log entry be completed by the person placing the call. Some commands require specific authorization for each long-distance call before the call can be placed.

Government telephones are intended for official business only. Most commands permit limited, brief, local telephone calls to be made to take care of personal matters that cannot be conducted during off-duty hours. However, the use of commercial long-distance services for personal business is prohibited and is always investigated. Detailed records of every commercial long-distance call (telephone bills) are forwarded monthly to each command for verification with the long-distance phone call records.

DEFENSE SWITCHED NETWORK.—The Defense Switched Network (DSN) is a telephone network servicing most military installations in the continental United States and overseas. This system is an upgraded, all-digital network that has replaced the former Automatic Voice Network (AUTOVON). The DSN incorporates many special features, such as automatic callback, call forwarding, call transfer, and call waiting. Instructions for use of the service and special options are included in the *DSN User Services Guide*, DISA Circular 310-225-1.

All telephone connections on the DSN are connected and maintained on a precedence basis (see table 1-1). Low precedence calls are initially connected only if there are free circuits available between the

caller and the destination. Higher precedence calls may initially be connected even if all circuits are in use by a process called "preemption." When no free circuits are found, the computer checks the precedence on calls in progress. A lower precedence call in progress will be terminated by the system to allow a higher precedence call to proceed. The calling parties of the lower precedence call hear a brief high-pitched tone on the line just before the line goes dead to indicate that their call has been preempted. The effectiveness of this system depends on the proper use of the precedence system. Each user should ensure that his or her call is not assigned a precedence higher than that justified by the circumstance or information involved.

Local command policy normally states that the DSN is to be used for official calls only. Personal or unofficial calls must never be initiated into the DSN system.

Telephone circuits, particularly those routed by high frequency and microwave, are susceptible to monitoring and interception. **The DSN is not a secure system!** Users must take care and use common sense to avoid divulging classified information. Giving hints or talking "around" a classified subject can lead to the compromise of classified information.

Table 1-1.—DSN Telephone Network Precedence System

PRECEDENCE	DESCRIPTION
FLASH OVERRIDE (FO)	Takes precedence over and preempts all calls on the DSN and is not preemptible. FO is reserved for the President of the United States, Secretary of Defense, Chairman of the Joint Chiefs of Staff, chiefs of military services, and others as specified by the President .
FLASH (F)	Preempts lower precedence calls and can be preempted by FLASH OVERRIDE only. Some of the uses for FLASH are initial enemy contact, major strategic decisions of great urgency, and presidential action notices essential to national survival during attack or pre-attack conditions.
IMMEDIATE (O)	Preempts PRIORITY and ROUTINE calls and is reserved for calls pertaining to situations that gravely affect the security of the United States. Examples of IMMEDIATE calls are enemy contact, intelligence reports essential to national security, widespread civil disturbance, and vital information concerning aircraft, spacecraft, or missile operations.
PRIORITY (P)	Preempts only ROUTINE calls. For calls requiring expeditious action or furnishing essential information for the conduct of government operations. Examples of PRIORITY calls are intelligence reports, movement of naval, air, and ground forces, and important information concerning administrative military support functions.
ROUTINE (R)	For official government communications that require rapid transmission by telephone. These calls do not require preferential handling.

Telephone Equipment

Most weather offices are equipped with multi-line telephones to handle normal business. Multi-line telephones contain six or more buttons in addition to the normal keypad. Depressing a button will switch the telephone to the number shown by the lighted button. Incoming calls activate a flashing light corresponding to the number of the incoming call. Normally, these telephones are on unprotected circuits, and classified information may not be discussed.

Additionally, *secure* telephones are found in many offices, and just about every weather activity has at least one telephone facsimile send and receive terminal.

SECURE TELEPHONE.—The Secure Telephone Unit-Third Generation (STU-III) is a communications system that meets the need for the protection of vital and sensitive information over a telephone system. The STU-III is a compact, self-contained, desktop unit capable of providing the user with both clear as well as secure voice and data transmissions (fig. 1-2). The STU-III is unique in that it works as an ordinary telephone and as a secure telephone network to other STU-III terminals. STU-III equipment may be used to provide secure communications on all commercial and military telephone networks. Full feature STU-III telephone terminals are equipped with modems that also allow clear and secure data transfer. However, some

telephone networks do not provide the high-quality, low-noise circuits necessary for data transmission.

The STU-III is operated the same way as any regular telephone. That is, you pick up the handset, wait for a dial tone, and then dial the number of the person you want to call. Calls on the STU-III are always initiated in the clear voice mode. Once the party you have called (at another STU-III terminal) has answered, you have the option of talking to that person in the clear voice or secure voice mode.

The STU-III terminal uses special keys with a designator of KSD-64A. The KSD-64A is a plastic device that resembles an ordinary key. Two types of KSD-64A keys are used with the STU-III, the seed key and the crypto ignition key (CIK). The seed key is special keying material used for the initial electronic setup of the terminal. The CIK is used by the operator to activate the secure mode. CIKs work only on the STU-III that they are issued with, and are unusable on all other terminals. More than one CIK may be issued with a terminal.

Calls are always initiated in the clear voice mode, exactly the same as a normal telephone call. For users to go from clear to secure voice transmission, both the calling and the receiving STU-III terminals must have the CIK inserted and turned a quarter turn clockwise. Then either caller may initiate the secure mode by pressing the "SECURE" button. Once a secure link has been initiated, the two STU-III terminals begin

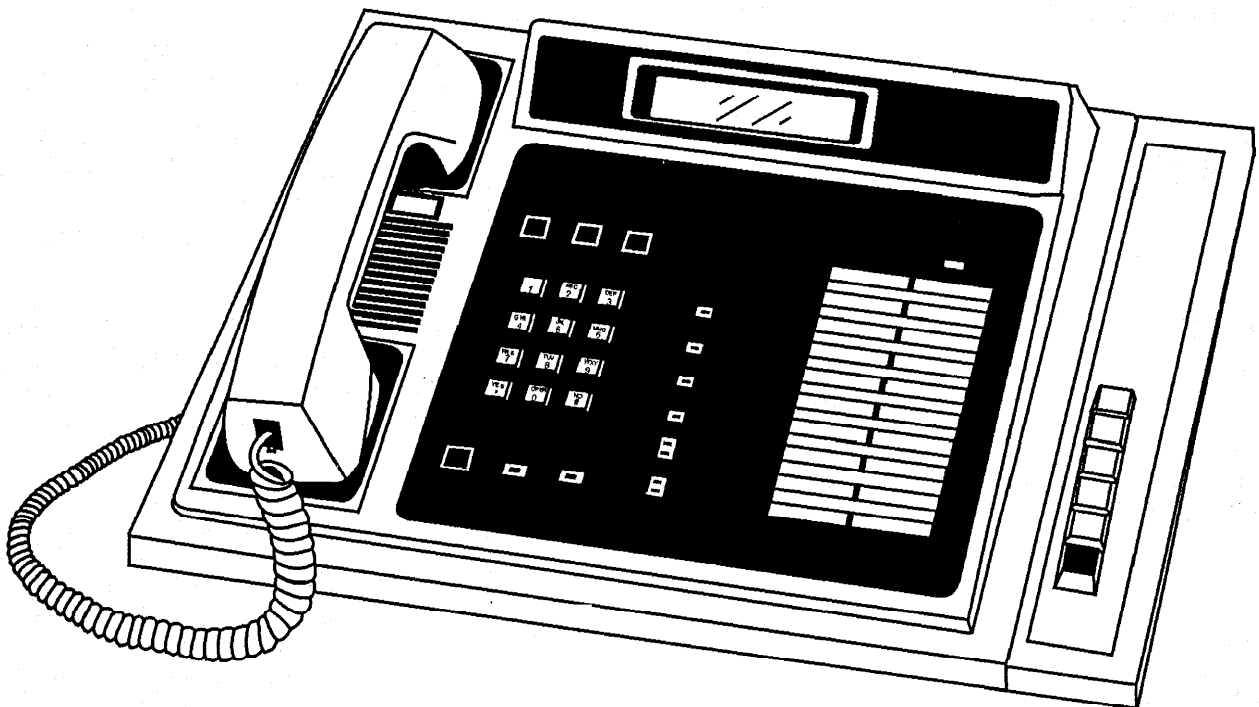

Figure 1-2.—STU-III terminal.

AGM4F102

exchanging information. When two terminals communicate in the secure mode, each terminal automatically displays the authentication (identification) information of the distant terminal, and a list of compromised CIKs. This information is scrolled through the display window during secure call setup. The first line of the identification information and the classification level are displayed for the duration of the secure call. The information displayed indicates the approved classification level for the call, but does not authenticate the person using the terminal. The terminal users are responsible for viewing this information to identify the distant party and the maximum security classification level authorized for the call.

Secure data transmissions using STU-IIIs may be made by connecting a computer modem phone plug into the MODEM plug receptacle on the backside of the unit, and then activating the "SECURE DATA" mode.

The STU-III terminals and keys are Communications Security (COMSEC) material and require special handling. The terminals and keys are administered through the STU-III COMSEC Account (SCA) Custodian. Both the terminals and keys that are issued to users must be signed for. Since the seed key is classified, it must be afforded protection in accordance with *Secure Telephone Unit Third Generation STU-III COMSEC Material Management Manual*, CMS 6. Although unkeyed STU-III terminals may be carried on mobile operations or exercises, the seed key is never transported, and the CIK key must be transported separately from the STU-III unit.

Because CIKs permit the STU-III terminals to be used in the secure mode, the CIKs must be protected against unauthorized access and use. CIKs may be retained by the users who sign for them on local custody. Users must take precautions to prevent unauthorized access and must remember to remove the CIKs from the associated terminals.

When the terminal is unkeyed, it must be provided the same protection as any high-value government item, such as a personal computer. When the terminal is keyed, the terminal assumes the highest classification of the key stored within it and must be protected in accordance with the classification of that key.

TELEFAX.—Nearly every command uses automatic telephone facsimile (telefax or fax) send and receive terminals to transfer graphic and written environmental information. This equipment may be used to transfer unclassified information only. Figure

1-3 shows an example of a pre-gummed 1.5-inch by 4-inch label containing certain information that should be included on every telefax. Some commands use a pre-printed cover-page containing this information.

# OF PAGES:	FROM
TO:	COMMAND:
COMMAND:	OFFICE CODE:
OFFICE CODE:	PHONE #:
FAX #:	FAX #:

Figure 1-3.—Example of a telefax address label.

Operation of telefax equipment is usually very simple. You place the original information on the feed tray, dial the destination fax number on the key pad or on the attached telephone instrument, and press the "send" key when a high pitched tone is heard in the receiver. Detailed instructions are normally attached to each terminal. The receive mode is fully automatic.

TELEPHONE MODEMS.—Telephone modems are electronic equipment that allow computers to transmit data directly over telephone circuits. Modems are also used to connect desktop computers to Local Area Networks (LANs) or to Wide Area Networks (WANs). There are many different modems in use throughout the Naval Meteorology and Oceanography Command. Most desktop computers now contain a built-in modem.

Modems are controlled via the computer with a special type of software program called a *communications protocol program*. These programs allow the operator to specify the telephone number to be accessed and to specify various communications parameters for the transmitted signal. It is beyond the scope of this training module to discuss the operating procedures for the various protocol programs or communications parameters. Operating instructions for each program are included with the program manual issued with the software. Specific protocol parameters allow the user to access programs such as NODDS.

The *Naval Meteorology and Oceanography Command Telephone and Address Listing* contains addresses, telephone numbers, and telefax numbers for all Naval Meteorology and Oceanography Command activities, Marine Corps weather activities, and offices of other military activities associated with meteorology and oceanography (*METOC*) support. Your Leading Chief usually maintains the directory and may provide copies at key telephone locations throughout your activity.

COMPUTER NETWORKS

The latest and fastest growing method of disseminating environmental information is through the use of computer networks. The advent of the information revolution has brought dramatic changes to the METOC community. Aerographer's Mates must now be proficient in accessing and transferring information in an automated environment. Almost all METOC activities, including those aboard ship, have access to some type of computer network.

A computer network consists of two or more computers connected for the purpose of exchanging messages and sharing data and system resources. A *local area network* (LAN) connects personal computers and workstations (each called a node) over dedicated, private communications links. A *wide area network* (WAN) connects large numbers of computers (nodes) over long distance communications links, such as common carrier telephone lines. An *internet* is a connection between networks.

The Internet

The Internet is a WAN that connects thousands of different networks all over the world, enabling anyone with a computer and Internet access to transmit and retrieve information worldwide. The Internet is not owned or funded by any one institution, organization, or government. It was originally developed by the Department of Defense in the late 1960's as a reliable communications network that, because of its simple design and versatility, could survive a nuclear attack.

Gradually, other government agencies, universities, and scientific organizations began to tap into the network. By 1983, newer networking protocols were developed, laying the foundation of the Internet we use today.

The development of Hypertext Markup Language (HTML) in 1990 significantly increased speed and capacity, and enabled users to transmit *graphical* information over the Internet for the first time. As an additional feature, HTML created the ability to insert hypertext *links* into a document. Hypertext links allow a user to load another document into their computer simply by clicking on an on-screen "link" from the current document. Subsequently, a huge hypertext network known as the World Wide Web (WWW) came into being in 1992. These developments enabled any individual or organization to create their own "website", and thus disseminate information over the Internet. Each website normally has an index or introductory document commonly referred to as a "homepage."

The Internet consists of several networks linked together via Internet Service Providers (ISPs) that use high-speed digital and fiber optic circuits. Each computer (client) must be connected to an Internet hub, known as a server. Servers are fast computers that are connected to the Internet full-time. They are located at different sites throughout the world, and direct Internet traffic to its proper destination. Today, the term "Internet" is used to refer to the physical structure of the Net, including client and server computers and the lines that connect them (fig. 1-4). The term "World Wide

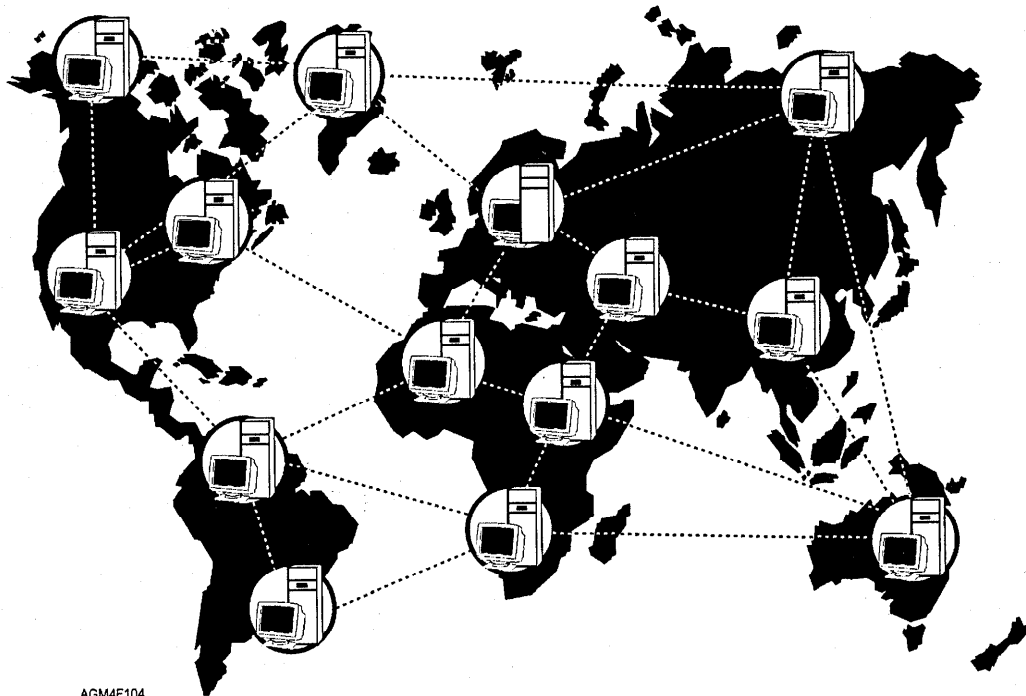

AGM4F104

Figure 1-4.—The Internet.

Web" or "Web" is generally used to refer to the collection of sites and the information that can be accessed from them when using the Internet.

There are several layers of the World Wide Web. These layers include networks operated by commercial

enterprises, private organizations, universities, the government, and the military (fig. 1-5). Each network contains thousands of individual websites that reside on web servers. The governing body of the Internet is an international organization known as InterNIC; it is

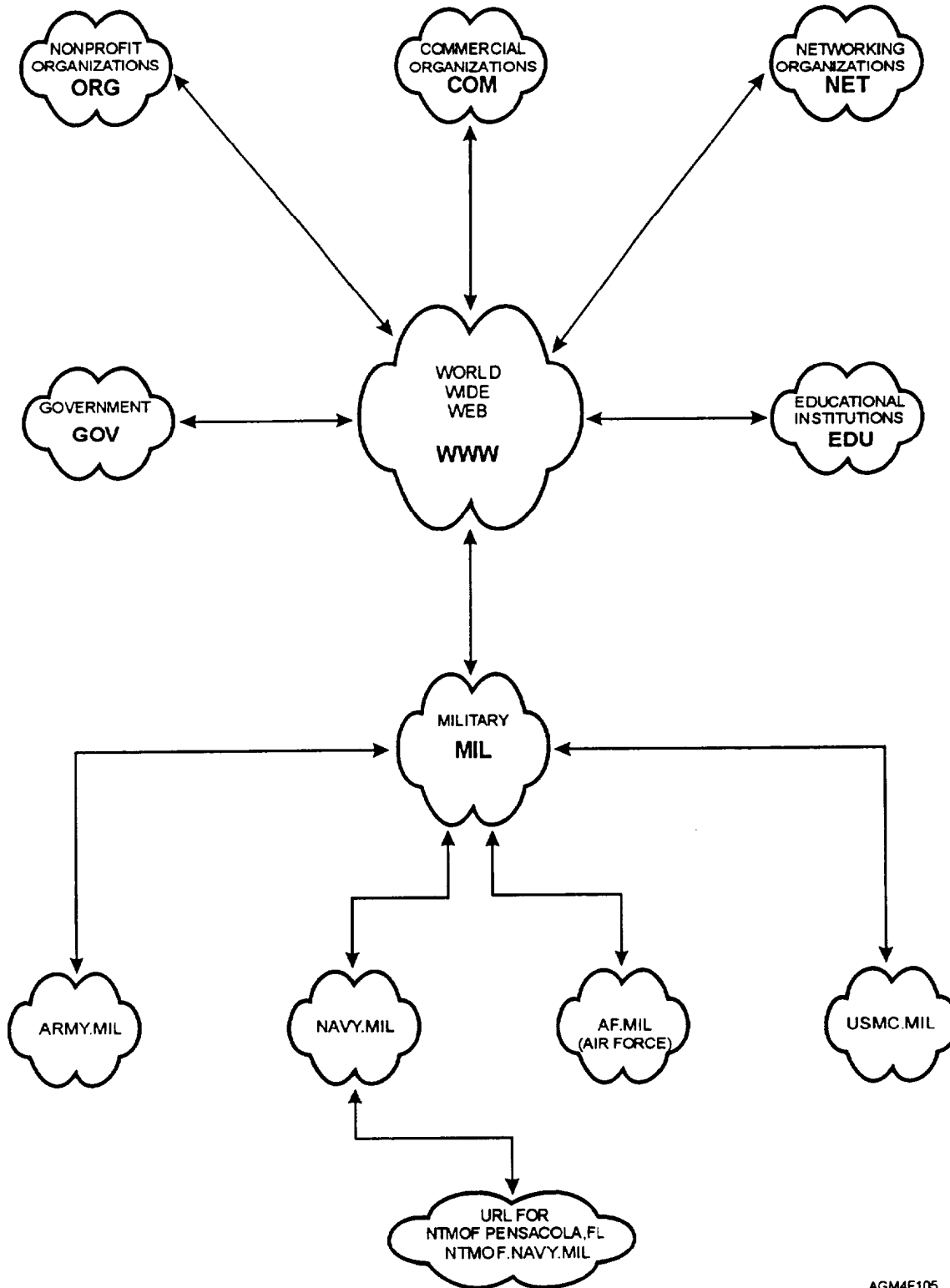

AGM4F105

Figure 1-5.—Various layers of the Internet.

located in Herndon, Virginia. InterNIC controls all Internet addresses and naming conventions.

Each website is identified by an address indicator known as a Uniform Resource Locator (URL). The URL is a unique alphanumeric code that allows you to quickly locate and access a specific website. A typical URL might read: <http://www.weather.edu>. The first part of the URL indicates the type of Internet protocol your computer must use. In this case, <http://> (hypertext transfer protocol), is used. The second part of the URL represents the name of the web server (www) followed by the website's domain ([weather.edu](http://www.weather.edu)). Most URLs end with an extension identifier that is used to access a particular network domain, such as [.edu](http://www.weather.edu) (educational institutions), [.com](http://www.weather.edu) (commercial websites), and [.mil](http://www.weather.edu) (military websites).

Websites can be easily accessed by using commercial software known as a *web browser*. As soon as you type in the URL of the website you wish to access, your browser goes to the web server that holds the page and retrieves it. If a specific website address is unknown, there are Internet search *engines* that can be used to rapidly locate websites pertaining to a particular area of interest. For example, a keyword such as "aircraft," or a more specific term, such as "F-14 Tomcat," may be used to easily locate information concerning that topic.

A wealth of information is available via the Internet. But keep in mind that since any individual or organization can develop their own website, not all the information is accurate or reliable. Also, keep in mind that the Internet is not a secure telecommunications network.

Military Networks

The U.S. military operates its own environment on the Internet that provides more security than commercial methods. This environment, known as the Defense Information Systems Network (DISN), is managed by the Defense Information Services Agency (DISA). It consists of two primary networks, the *NIPRNET* (Nonsecure Internet Protocol Routing Network) and the *SIPRNET* (Secure Internet Protocol Routing Network). These networks require special dedicated circuits as directed by higher authority. Most Navy and Marine Corps METOC activities have NIPRNET access, and many also have SIPRNET access. In addition, almost all METOC activities, including most ships, maintain their own website (or homepage). Each of these websites may contain

information on command history and mission, as well as provide access to various environmental products. Figure 1-6 is an example of the Naval Training Meteorology and Oceanography Facility (NTMOF), Pensacola, Internet homepage.

A tremendous amount of environmental information can be downloaded from various METOC activities. The NIPRNET and SIPRNET can be used to access environmental data from the website at the Fleet Numerical Meteorology and Oceanography Center (FNMOC), Monterey, California, including Navy Oceanographic Data Distribution System (NODDS) products and products from the Joint METOC Viewer (JMV). User manuals for NODDS, JMV, and other software programs can also be downloaded via the FNMOC website. In addition, there are several nonmilitary and nongovernment websites that contain valuable environmental information, which include looped satellite images, current weather maps, climatological data, and so forth. Many METOC websites include links to other sites with related information. Table 1-2 contains a listing of some of the most frequently accessed METOC-related websites.

Bulletin Board Systems

There are still a few environmental software programs that are available via bulletin board systems. Bulletin board services are acquired by dialing a telephone number for access to government computer networks. All government bulletin board services, including NODDS, require user identification codes and passwords. These are provided along with detailed operating instructions for all registered system users. All user identification codes and passwords must be protected and should never be disclosed to unauthorized users. Once user identification and passwords have been entered, your computer will be connected to the bulletin board system.

Electronic Mail

Electronic mail or e-mail is the electronic transmission of messages, letters, documents, and other materials via a communications network, such as the Internet. It allows computer-based messages to be electronically edited, replied to, or pasted into another electronic document. Most e-mail allows messages to be sent to multiple recipients. E-mail may even contain graphics, sound, and video attachments. Messages or files are sent to "accounts" or *electronic mail addresses*. An e-mail address is a unique identifier that is used to



Naval Training Meteorology and Oceanography Facility Pensacola, FL

**YOU HAVE JUST ENGAGED AN OFFICIAL
UNITED STATES NAVY WEB INFORMATION SERVICE**

[DOD Warning Statement](#)

[Privacy and Security Notice](#)

[General Disclaimer](#)

METOC Products

Pascagoula Support

About NTMOF

Fleet Training Department

Feedback, Products request

Forecast Duty Officer:
DSN 922-3644
COM 850-452-3644

Mail to NTMOF
WebMaster c/o
cdontmof@ntmof.navy.mil

Command Mission

To provide within areas of responsibility (AOR), as assigned by the Commander, Naval Meteorology and Oceanography Command, operational meteorology and oceanography (METOC) services to the Armed Forces of the Department of Defense (DoD).

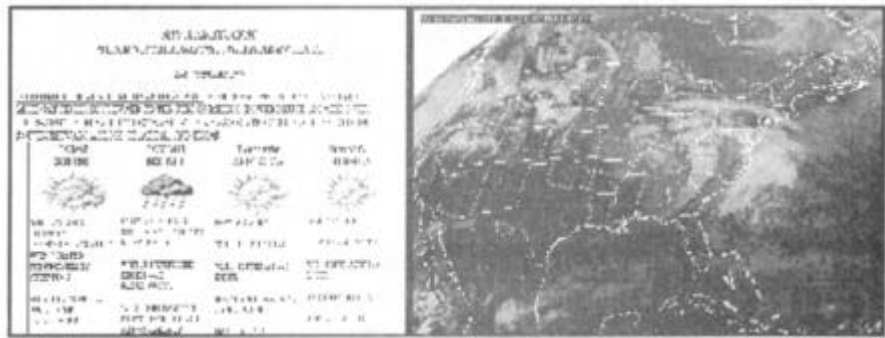

[Click Here for Today's Forecast](#)

[Click Here for the Latest Satellite
Picture](#)

Figure 1-6.—NTMOF Pensacola Internet homepage.

send electronic mail to a specified destination. The recipient can be on the same server as the sender or on a server halfway across the world. The only restriction is that you must know the address of the person you wish to send e-mail to. An e-mail address usually appears as a user name, followed by an @ symbol, followed by the host name of the destination computer, such as "doe@acme.com. The addresses are normally case sensitive, and the spelling of the surname and of the site must be exact, or the message will not arrive at the recipient's computer.

WEATHER COMMUNICATIONS NETWORKS

There are several telecommunication networks dedicated solely to environmental information. The largest is the DOD Global Weather Communications System (GWCS). It is operated by the U.S. Air Force and provides rapid transmission of aviation weather support information to military facilities. The system includes the Automated Weather Network (AWN) and the Air Force Global Weather Intercept Program (GWIP) network.

Table 1-2.—METOC Related Websites

ORGANIZATION	WEBSITE URL
CNMOC Stennis Space Center	www.cnmoc.navy.mil
NAVO Stennis Space Center	www.navo.navy.mil
FNMOC Monterey, CA.	www.fnmoc.navy.mil
NLMOC Norfolk, VA.	www.nlmoc.navy.mil
NPMOC Pearl Harbor, HI.	www.npmoc.navy.mil
NPMOCW Guam	www.npmocw.navy.mil
NEMOC Rota, Spain	www.nemoc.navy.mil
NEPRF Monterey, CA.	www.neprf.navy.mil
NTMOF Pensacola, FL	www.ntmof.navy.mil
FNMOD Asheville, NC	waves.ncdc.noaa.gov/temp/fnmod.htm
FNMOD Tinker AFB	www.fhmoc.navy.mil/~tinker
AFWA Offutt AFB, NE	afwin.afwa.af.mil:443
NWS Climatic Data	tgsv5.nws.noaa.gov/climate.shtml
NWS Eastern Region	tgsv5.nws.noaa.gov/er/hq/index.html
NWS Southern Region	www.srh.noaa.gov
NWS Western Region	www.wrh.noaa.gov/wrhg
NWS Pacific Region	tgsv5.nws.noaa.gov/lprlpacific.shtml
NWS Alaska Region	www.alaska.netf-nwsar/
Weather Channel	www.weather.com
John Hopkins University	www.jhuapl.edu/weather
University of Wisconsin	www.meteor.wisc.edu/weather.html
Penn State University	www.psu.edu/weather
University of Michigan	cirrus.sprl.umich.edu/wxnet

Automated Weather Network

The AWN is a global network of satellite and landline circuits linked with Automated Weather Data Switch (AWDS) computers used to collect and disseminate environmental data and other aviation related information. The military segment of the AWN is composed of two major subsystems: the Air Force Meteorological Data System (AFMEDS), and the Notice to Airmen (NOTAM) service for all DOD activities. The center of the network is a computer complex at Tinker AFB, Oklahoma. These computers collect large quantities of unclassified environmental observations, forecast bulletins, and specialized guidance products from a variety of sources, including

the National Weather Service (NWS), the Air Force Weather Agency (AFWA) at Offutt AFB, Nebraska, and the Fleet Numerical Meteorology and Oceanography Center. International environmental information is forwarded from the World Meteorological Organization (WMO) data collection center via the NWS and is also collected and entered into the AWN through the GWIP network.

The Fleet Numerical Meteorological and Oceanography Detachment (FNMOD) at Tinker AFB, Oklahoma, is responsible for coordinating and validating Navy and Marine Corps environmental data requirements for the AWN. They also manage and schedule Navy data requirements on the Fleet

Environmental Broadcast circuits that are keyed to the AWN. FNMOD Tinker also provides guidance on AWN data formats and can assist with preparing request messages for AWN products. Detailed information on the AWN can be obtained from the FNMOD Tinker homepage at <http://www.fnmoc.navy.mil/~tinker/>.

AFMEDS.—The data network used to support Air Force, Navy, and Marine Corps meteorological facilities within the United States is called the *Continental United States (COWS) Meteorological Data System*, or *COMEDS*. In the early 1970's, the service was expanded to include the *European Meteorological Data System (EURMEDS)*, the *Pacific Meteorological Data System (PACMEDS)*, the *Atlantic Meteorological Data System (ALTMEDS)*, and an *Alaskan Meteorological Data System (AKMEDS)*. These services are subsystems of the *Air Force Meteorological Data System*, or *AFMEDS*. Most of these dedicated landline circuits will be phased out by early next century as the NIPRNET becomes the primary method of transmitting AWN data. Software known as the Message Format Transmitter (MFT) module will be incorporated into the Meteorological and Oceanographic (METOC) Interactive Data Display System (MIDDS) to complete this changeover. However, the actual AWN data formats will not change. Ships will continue to receive AWN data via the Fleet Environmental Broadcast, which is discussed later in the chapter.

ARQ Requests.—Incoming environmental information is stored in the AWN computers in files identified with a MANOP heading. (MANOP headings will be discussed in more detail shortly). As each observation or product is received in the computer, the data is forwarded to all units that have listed that particular MANOP as part of their data requirements. Additionally, any activity connected to the system may request individual products that are not on their data requirements list by a process called *Automatic Response to Query*, or ARQ. Individual activities may also use the system to transfer specific support products from a forecast activity, such as a detachment, to any other activity on the system.

MANOP Headings.—The use of MANOP headings is the key to data retrieval from the system. MANOP headings conform to WMO product identification guidelines as well as to the International Civil Aviation Organization (ICAO) guidelines for station identification. Every MANOP must follow the general format

TTAA(ii) CCCC YYGGgg (mod)

where

TT is the data content identifier—a two-letter code for the type of data contained in the bulletin or message;

AA is the Geographical designator—a two-letter code for the region covered by the data in the bulletin or message;

ii is a two-digit series number assigned to products containing similar data for similar areas, and issued by the same originating station;

CCCC is the four-letter ICAO station identifier for the station originating or compiling the information in the bulletin;

YYGGgg is the UTC date-time group (DTG) of the information within the bulletin or message, with *YY* as the day, *GG* as the hour, and *gg* as the minutes; and

Mod is a modification indicator—an abbreviation showing that a change has occurred in an otherwise routinely scheduled message. Mod indicators are "RTD" (routine delayed) and "COR" (correction).

Each product entered in the system must contain the proper MANOP header before being entered into the system. However, transmissions of some routine products, such as standard military station weather observations and terminal aerodrome forecasts (TAFs) are normally sent through the system without MANOPs. Instead, they are grouped into a collective by the system, and then assigned a MANOP by the AWN computer.

Appendix II provides a breakdown of the various MANOP data type identifiers (*TT*) and geographical designators (*AA*) used within the system. A complete listing of available data in the AWN system can be obtained from the AFWA Detachment 7, Tinker AFB website: <http://137.240.101.95>, and the FNMOD Tinker website.

NOTAMS.—The AWN also provides communications for the worldwide military NOTAM system. The Air Force Central NOTAM Facility (AFCNF) in Washington, D.C. collects and retransmits NOTAMs from all military airfields as well as civil aviation NOTAMs from the FAA NOTAM facility in Atlanta, Georgia. NOTAMs report items of interest to

aviators, such as temporary or permanent runway closures, radar, communications, or guidance systems outages, or changes in available facilities at an airfield. At most military airfields, NOTAMs are directed to a separate AWN terminal in the base operation office. During terminal outages, these NOTAMs may be redirected to the AWN terminal in the weather spaces. Navy and Marine Corps weather observers should coordinate directly with the local base air traffic controllers to arrange for pickup of NOTAMs when received over a weather circuit.

Air Force Global Weather Intercept Program

The Air Force Global Weather Intercept Program (GWIP) is another major function of the GWCS. Air Force radio intercept sites around the world routinely intercept meteorological and oceanographic information broadcast from other nations that would otherwise be unavailable for use. This information is transmitted by other nations knowing that it will be intercepted and used. This is part of the data exchange program governed by the World Meteorological Organization data exchange agreements. The intercepted data is entered into the AWN, and large amounts are forwarded to the National Weather Service and FNMOC to supplement foreign data received from other sources. Most of the data is used for automated global scale analysis programs. Some selected data is directed to the Fleet Environmental Broadcast, which is discussed later in this chapter.

DIGITAL FACSIMILE

Several shore sites receive the National Weather Service Digital Facsimile (DIFAX) satellite broadcast. The broadcast originates at the National Centers for Environmental Prediction (NCEP) located at Camp Springs, Maryland, and it is then distributed via a continuous satellite broadcast from the National Weather Service office at Silver Spring, Maryland. A small 18-inch dish antenna is used to capture the broadcast signal at each receiver site.

The MIDDs is equipped with a special receiver module that can ingest DIFAX products as necessary. A few weather offices still use a desktop computer to analyze the signal and print the graphic products on a standard printer. No operator maintenance is required for the equipment other than periodically reloading paper, replacement of printer ribbons, and a periodic vacuuming of lint and dust from the printer.

The DIFAX uses product codes for each product. Operators access the command function via the computer keyboard, and use the product codes to specify which products are to be displayed or printed, and which products are to be ignored. The product codes are included on the facsimile transmission schedule. Transmission schedules are periodically broadcast and are also available via the Internet from the DIFAX service offices at NCEP.

The DIFAX broadcast should be discontinued by late 1999 as the NWS Advanced Weather Interactive Processing System (AWIPS) becomes fully operational. Most products currently available from this service and routinely used by military weather personnel are now available via NODDS and JMW.

So far, we have covered the various telecommunications systems you will use in the Navy. In the next section, we will discuss how you will access this information.

REVIEW QUESTIONS

- Q4. Before a long distance commercial call can be made from a government telephone system, what action must be completed?*
- Q5. What is the purpose of the STU-III?*
- Q6. What are Internet "links" used for?*
- Q7. What is the function of a network server?*
- Q8. How are military URLs identified?*
- Q9. What Internet routing system is used to transfer classified information between military activities?*
- Q10. What types of information may be obtained from a METOC-related military website?*
- Q11. What information must be included in an e-mail address?*
- Q12. What is the purpose of the AWN?*
- Q13. What organization is responsible for coordinating and validating Navy and Marine Corps AWN data requirements?*
- Q14. How can you obtain weather information via the AWN that is not routinely received by your command?*
- Q15. The TT and AA indicators of a MANOP header are used to identify what information?*
- Q16. What information is contained in a NOTAM?*
- Q17. How are DIFAX products copied?*

ENVIRONMENTAL WORKSTATIONS

LEARNING OBJECTIVES: Identify the primary environmental workstation used by NAVMETOCCOM. Identify the major features and software programs associated with this system.

Over the past decade the Navy has developed various METOC related PC-based systems designed to take advantage of computer technology. The original PC-based systems were integrated into Navy and Marine Corps weather offices to acquire, process, display, and disseminate meteorological and oceanographic data. Unfortunately, these original "stand-alone" PC systems took up much workspace and required more operator personnel than were available.

In the early 1990's, the first computer *workstation* developed for the shore-based Navy METOC community was introduced. This system, known as the CONTEL Meteorological Workstation (CMW), was a desktop computer system with multiple communication and display functions. It consolidated the various stand-alone systems into a single client-server system and was

capable of simultaneously sending, receiving, storing, recalling, printing, and processing alphanumeric data. It also generated color graphics from processed data. By the late 1990's, the CMW was being replaced by the Meteorology and Oceanography Integrated Data Display System (MIDDS), which is discussed in the following text. A shipboard version of an environmental workstation known as the Tactical Environmental Support System (TESS) will be discussed later in the chapter.

METEOROLOGY AND OCEANOGRAPHY. (METOC) INTEGRATED DATA DISPLAY SYSTEM (MIDDS)

The Commander Naval Meteorology and Oceanography Command (CNMOC) tasked the Naval Oceanographic Office (NAVO) to develop the Meteorology and Oceanography (METOC) Integrated Data Display System (MIDDS). This system combines both government and commercial application software. The Windows-NT operating system is the base software.

MIDDS provides three primary functions. First, MIDDS is an environmental workstation where the weather forecaster or observer retrieves, processes, and



Figure 1-7.—MIDDS workstation.

displays various weather products. Second, MIDDS is a briefing station that features high-quality graphics and enhancement features. Finally, MIDDS distributes meteorology and oceanography products locally over a Bulletin Board System (BBS), the Internet, or Local Area Network (LAN). The MIDDS workstation is normally equipped with a four-monitor display unit that is used for pilot briefings and product visualization. Figure 1-7 shows the MIDDS workstation.

The MIDDS workstation requires the user to have a working knowledge of Windows NT and its functions. The hardware includes a dual-processor 486 Pentium computer with 64 megabytes of RAM, a 2-gigabyte hard drive, a CD-ROM drive, 21- and 17-inch high-resolution monitors, modems, uninterrupted power supply (UPS), keyboard, and receiver card. Complete information concerning the operation of MIDDS can be found in the *Meteorology and Oceanography (METOC) Integrated Data Display System (MIDDS) User's Guide*. We will discuss the various features and software programs of the MIDDS in the following text.

Router Modules

The MIDDS router (and receiver) modules are software programs that run continuously in the background and can be accessed only from the main server of the system. The router module controls all data reception and is responsible for all the system management functions. The router identifies, sorts, stores, and sends data to the appropriate directories. When the MIDDS is turned on, Windows NT

automatically activates the router and receiver modules. To display the router window, you must click on the Router icon found in the "Ingest Monitor Window," as shown in figure 1-8. Your system administrator normally accomplishes all initial settings for the router during installation.

There are nine major system management functions of the router and they must be activated to run. Some of the most important router functions include an audio alarm option, an auto printing option, and automatic file conversion for ingested products. A few other important functions are discussed in the following text.

PURGING.—Purging is the most important system management function of the router module. The purger maintains the correct number of each type of product on the hard drive. The purger deletes the oldest version of a product file and replaces it with the newest version. In the original MIDDS, purging was optional. With MIDDS 2.0 and later, purging will be accomplished automatically and continually in the background.

DISK MIRRORING.—In a few cases, you may want to copy products to a different location other than where they are normally stored. This function will automatically copy specified products to another disk drive or to another computer over the network. The Disk Mirroring function allows you to maintain a suite of products in case the main MIDDS server fails.

FTP (FILE TRANSFER PROTOCOL) PROCESSING.—This function is responsible for automatically sending products and files to another

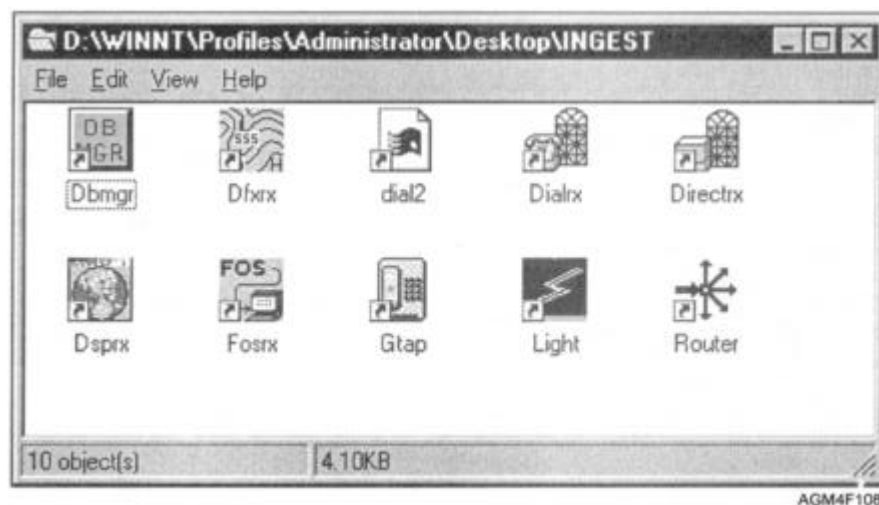

Figure 1-8.—MIDDS Ingest Monitor screen.

computer system over a network. The operator may choose to reroute selected files and products to remote sites on a predetermined schedule. The FTP function can be used to send critical tiles to a remote site. Only one file may be sent at a time.

ARCHIVING.—Aircraft accidents, storm tracks, and high interest areas provide good reasons to save environmental data. The archive function allows you to save individual products and files to floppy disk. As data is received, it is automatically copied to the destination path and drive.

FUSION GENERATOR.—This function allows you to overlay various METOC products, such as a satellite image with a radar image. The operation can be set up automatically for predefined products at specified time intervals. There are several map projection and color scheme options available. In addition, alphanumeric data ingested from the AWN can also be fused with other geo-referenced products. This allows you to overlay any type of data, such as sea level pressure contours with temperature contours, surface winds with precipitation, and so forth.

Receiver Modules

The MIDDS has several receiver modules that define which products to receive from satellite data, radar data, AWN data, and digital facsimile data.

SATELLITE (DSP) RECEIVER.—This module allows for the reception of satellite images from GOES-Tap, HF receiver, APT, or WEFAX. The images are stored in PCX format and can be captured in several sizes. Images can be viewed as they are being received, and a looper display capability is provided. A database of several different satellites is loaded during installation. (Digital GOES 8 and 9 imagery will be received over the Internet or via the Dial RX receiver.)

DIFAX RECEIVER.—This module allows you to receive digital facsimile products from the National Weather Service. Your system administrator will establish a DIFAX product database during installation.

DIAL RX RECEIVER.—This module acquires radar images from WSR-88D radar sites by using a commercial dial-up service or the Internet. It can also be used to receive GOES satellite images, alphanumeric products, and DIFAX products.

The DIAL RX accesses a master database that contains all meteorological stations, including those stations with WSR-88D radars. (The database also contains all satellite and DIFAX product types.) From

this database, specific stations can be selected (activated), and desired products can then be selected from that particular station. Keep in mind that only those radars sites near your station need be activated. After you select the WSR-88D station, you then select from a list of products that you desire. Your system administrator can establish a predefined product list for each WSR-88D station. At some activities, the MIDDS computer is directly connected to a WSR-88D Principal User Processor (PUP) circuit by using a CODEX modem.

AWN RECEIVER.—This module allows observation and forecast data from the AWN to be ingested into the MIDDS. MIDDS is designed to receive AWN data, identify desired stations and products, and store the data in appropriate directories. The number of active stations can be selected from the master station database. Data requirements are usually determined through the system administrator. MIDDS ingests AWN data continuously, and a large volume of data is received. Thus, the amount of data selected for ingest must be determined very carefully.

LIGHTNING-DATA RECEIVER (LDR).—The LDR receives input from the Lightning Detection and Tracking System (LDATS). The LDATS system displays lightning data collected by the National Lightning Detection Network (NLDN), which consists of over 100 remote sensing stations that monitor cloud-to-ground lightning in the continental United States. The LDR receives LDATS data so that MIDDS can display it on a user-defined map background. This display can be an individual LDATS product or overlaid on top of radar and satellite products. MIDDS can also display the lightning data at specified time intervals.

Weather Group Applications Software

The primary function of MIDDS is to display satellite imagery, radar imagery, alphanumeric text, and weather charts. MIDDS has several data-display applications available for weather briefings, along with numerous other data manipulation and display features. The main display applications in MIDDS are SAND (Satellite, AFOS, NEXRAD, and DIFAX) and FOS (Family of Services).

SAND (SATELLITE, AFOS, NEXRAD, and DIFAX).—The SAND application is used to display three types of products: Satellite imagery, NEXRAD (WSR-88D next-generation radar data), and digital facsimile data. AFOS is the commercial way of

displaying alphanumeric data and is not used in MIDDS. SAND gives the user the ability to manipulate and display these products in several ways. The operator selects from various menu boxes and bars using the Windows format. Additional menu options allow the user to pan/zoom and rotate images, add weather symbols to displays, loop images, and automatically display range-bearing information. Customized color enhancements can also be created. The SAND application also executes automatic station plots, contour plots, Skew-T plots, and even time-series plots (fig. 1-9).

FOS (FAMILY OF SERVICES).—The Family of Services (FOS) is the applications module used to display and manipulate alphanumeric data. Forecasters need TAFs, station observations, and general text messages to successfully provide quality forecasts. The type, age, amount, and location of the data can be tailored for the needs of each forecaster.

MIDDS can display information by using three different formats: *areas* (a geographical area, such as Nevada), *routes* (two weather stations connected by a line), and *groups* (a random group of stations). As with the SAND application, the operator selects from various menu boxes and bars using the Windows format. Individual stations can be sorted by either station ID or name. Once the desired station is selected, the required products for that station are then selected. The data can be viewed, edited, printed, or archived.

Briefing Support

MIDDS contains a briefing support program designated as "Weather Brief." It provides the capability to create an environmental brief composed of satellite, radar, alphanumeric products, or other user-defined products from MIDDS application programs. Two different types of briefs can be created, dynamic or static. In a "dynamic" brief, products in the brief are automatically updated when new ones are ingested into

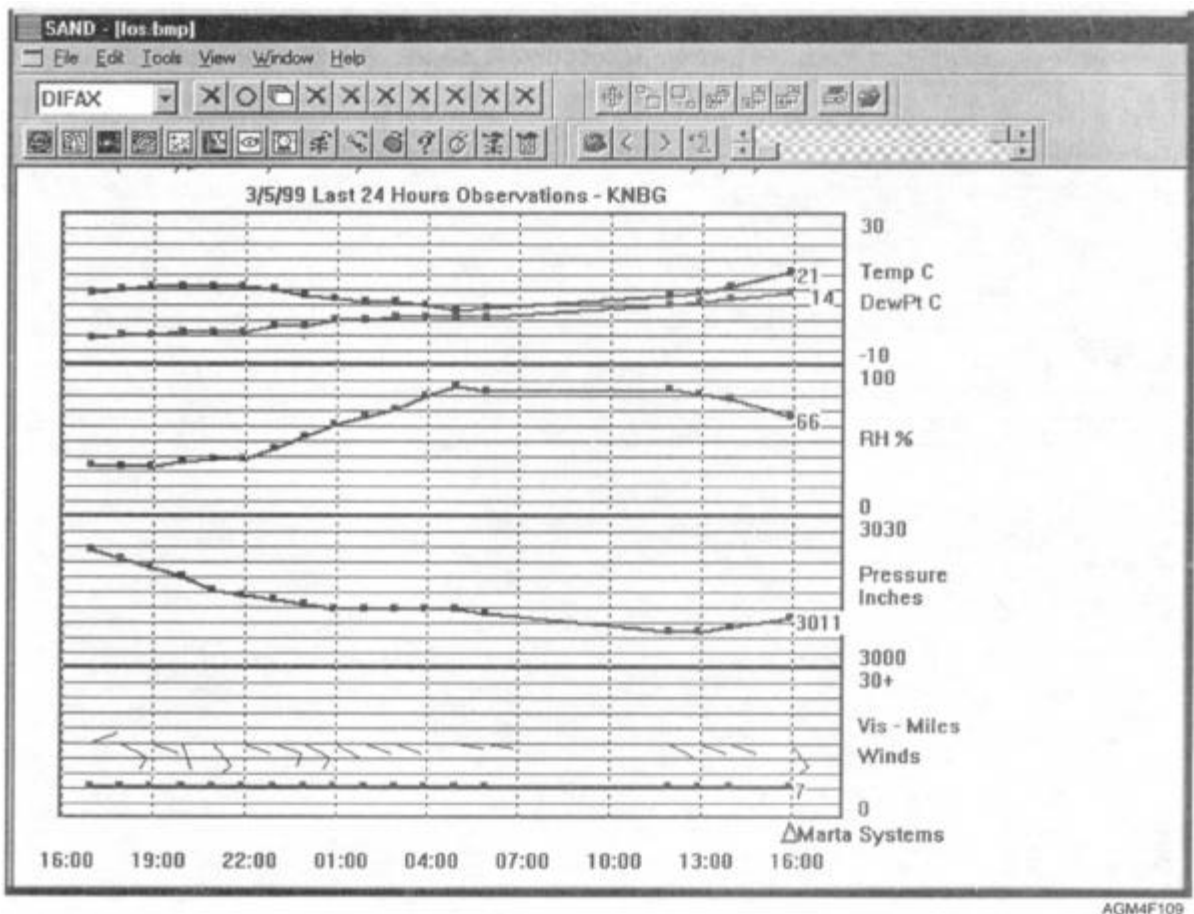

Figure 1-9.—MIDDS time-series plot.

the MIDDS. In a "static" brief, the products are saved and are not updated when new ones are ingested into the MIDDS. A static brief is essentially a snap shot of weather data at a specific point in time. This information can be quite useful during major weather events. The idea is to preserve your data for future reference. MIDDS can also display a brief over a LAN through a web browser with Hypertext Markup Language (HTML). You may create multiple briefs tailored for many users.

In addition, the MIDDS weather brief program will enable aviation weather forecasters to provide computerized flight weather briefing forms (DD Form 175-1) while remaining in accordance with NAVMETOCCOMINST 3140.14, *Procedures Governing Flight Weather Briefings and Preparing DD Form 175-1 and U.S. Navy Flight Forecast Folder*. This program contains the entire DD Form 175-1 and is subdivided into its respective parts (I through IV). The program is designed to automatically ingest TAF and observation data from the AWN and place it on the form

(fig. 1-10). All DD-175-1 briefs may be archived to a floppy diskette or another hard drive.

Automated Surface Observing System (ASOS)

A communications link between MLDDS and the Automated Surface Observing System (ASOS) may be established. The software for this application is divided into two main sections, ASOS Data Server and ASOS Data Manager. The ASOS Data Server is a software program providing ingest and dissemination of 1-minute surface observation data from the ASOS. The other software program is the ASOS Data Manager. This application provides a display of both current and historical ASOS data in an easy-to-use method. The main display consists of a menu bar, two graphs, panes for the latest reported observation, wind speed and direction dials, and a "current status" banner (fig 1-11). The two graphical displays are "strip charts," which can provide visual analysis of weather phenomena trends, such as temperature and wind speed. As an additional feature, alarms can be set to go off when station

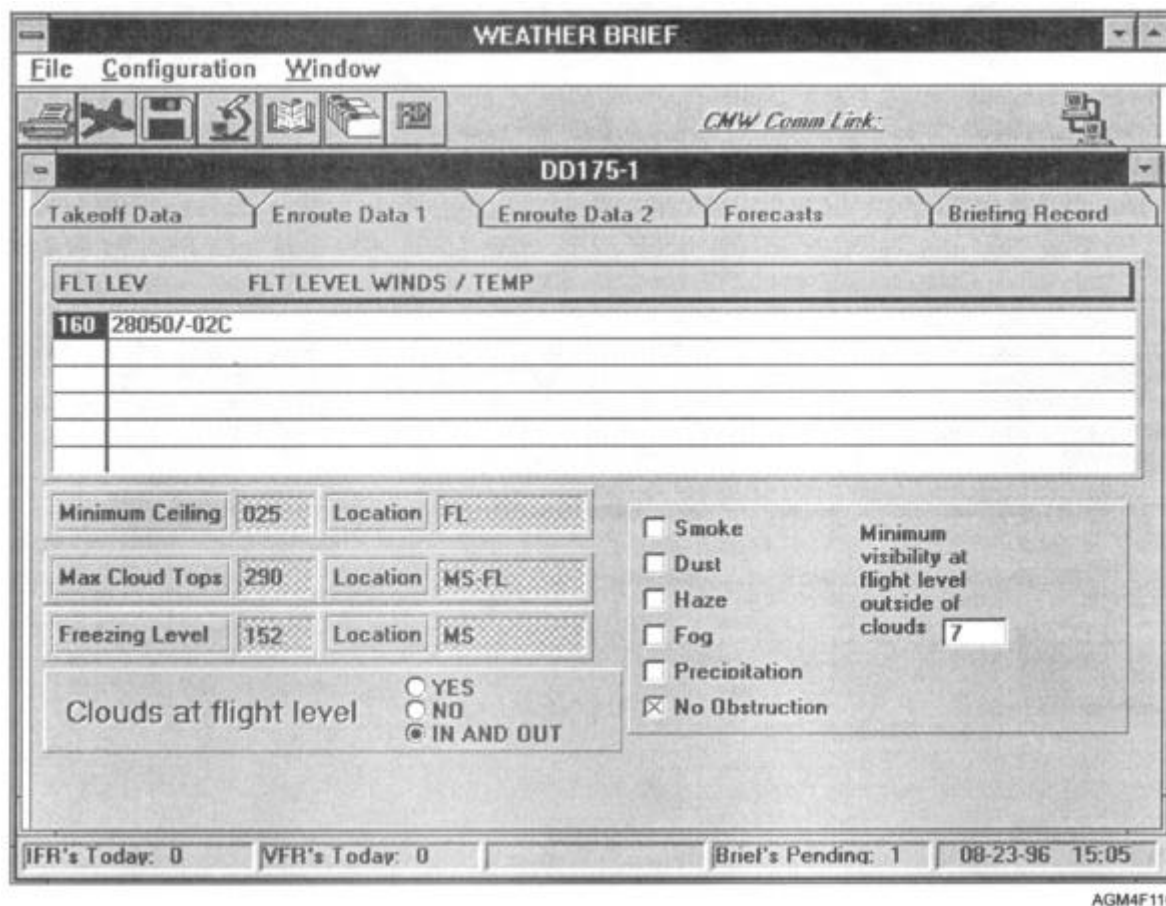

Figure 1-10.—Flight weather briefing form (DD Form 175-1) constructed using MIDDS.

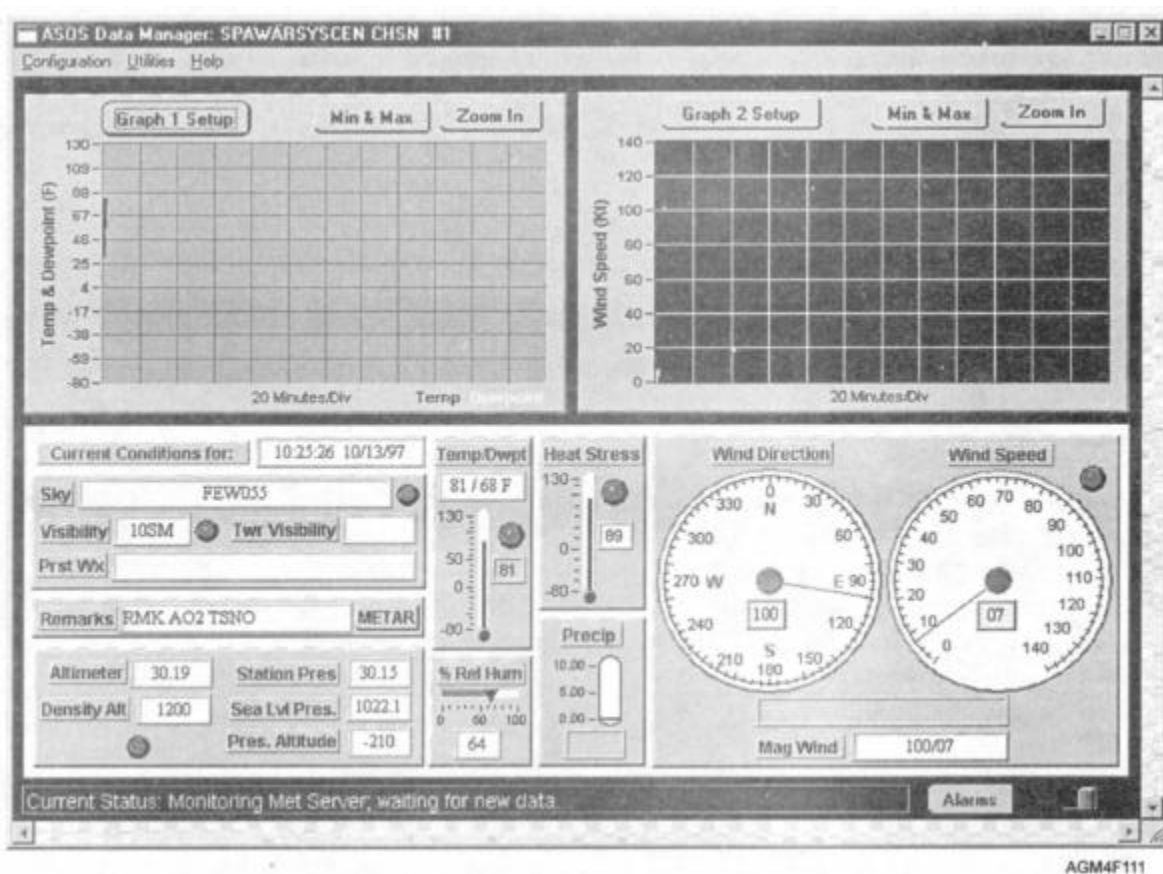

Figure 1-11.—ASOS Data Manager main display window from MIDDS.

minimums, such as ceiling and visibility are reached. When the Message Format Transmitter (MFT) software is installed, it will provide templates for surface observations and TAFs, perform quality control checks for observations, and automatically transfer observation data to the AWN and to FNMOD, Asheville, for archive.

Internet and Bulletin Board Access

MIDDS provides direct dial-in and Internet connectivity into the Navy Oceanographic Data Distribution System (NODDS), the Optimum Path Aircraft Routing System (OPARS), and the Joint METOC Viewer (JMV). All of these programs originate at FNMOG and are discussed in detail in chapter 2 of this module.

GF MPL GROUP APPLICATION SOFTWARE

The Geophysics Fleet Mission Program Library (GF MPL) is a software library that provides

meteorological, electromagnetic, oceanographic, hazard avoidance, and acoustic support for fleet operations. MIDDS includes the "Unclassified" portion of GF MPL integrated into a Windows NT format. Certain electromagnetic assessment parameters are omitted from the standard GF MPL modules available in the classified version. Some of the GF MPL programs that are available include tidal prediction, tropical cyclone track, and surf prediction. An on-line user's guide is available with the MIDDS. The GF MPL program is discussed in detail in chapter 2 of this module.

REVIEW QUESTIONS

- Q18. What are the primary functions of MIDDS?
- Q19. What is the purpose of the MIDDS Fusion Generator module?
- Q20. What products are acquired by using the MIDDS Dial RX receiver?

- Q21. The MIDDS SAND application is used to display what types of information?
- Q22. What is the function of the MIDDS FOS module?
- Q23. A Flight Weather Briefing form (DD-175-1) can be completed by using which MIDDS application?
- Q24. Which MIDDS software application tool can provide temperature trend graphs for your station?

NAVAL MESSAGE TRAFFIC

LEARNING OBJECTIVES: Identify the primary message traffic system used by the Navy. Identify the various parts of a standard Naval message. Identify the publication that outlines procedures for formatting Naval messages. Identify the message formatting software used by the Navy. Interpret and format a Naval message readdressal. Explain the term *minimize*.

The Navy sends thousands of messages each day. As an Aerographer's Mate, you will be required to draft naval messages. You must be able to recognize the various parts of a standard Naval message as well as possess a working knowledge of the message drafting software used by the Navy.

The primary message traffic system currently used by the Navy is the Automatic Digital Network (AUTODIN). As communications technology continues to develop, this system will be phased out as the Navy moves to desktop message creation and transmission. Within the next few years, all message traffic will be transmitted via an e-mail type system known as the Defense Message System @MS). The goal of DMS is to retain the easy-to-use and less expensive individual messaging capabilities employed in DOD e-mail systems. This will shift message handling functions away from manpower intensive communications centers to the user's desktop. The changeover to DMS will continue through the late 1990's and into the next century.

AUTOMATIC DIGITAL NETWORK (AUTODIN)

The Automatic Digital Network (AUTODIN) is a joint-use, worldwide, computerized, communications

system. It is managed by the Defense Communications Agency (DCA). AUTODIN provides for the transmission of both narrative and graphic data traffic on a store-and-forward basis. AUTODIN provides reliable, secure, and efficient communications using high-speed transmission equipment that incorporates error detection. Interface equipment translates all input into common machine language, thereby making AUTODIN compatible with many computer codes, speeds, and other media, such as cards and tapes.

The Naval Communications Processing and Routing System (NAVCOMPARS) is an automated communications system that serves as the interface between AUTODIN, other networks ashore, and operational units of the Navy. AUTODIN traffic is entered into NAVCOMPARS for distribution. NAVCOMPARS forwards messages to fleet units and provides broadcast management and HF or satellite broadcast keying. It also provides on-line communications with the Common User Digital Information Exchange System (CUDIXS) and the Fleet Multichannel Broadcast (FMCB).

The *Gateguard* subsystem is an AUTODIN Gateway Terminal (AGT) that provides the user a "gateway" into the AUTODIN system. It essentially provides secure electronic message service from the telecommunications center to the user's desktop computer. Gateguard also acts as a security guard device, hence the name Gateguard. Users may also use Gateguard to route incoming messages to various offices via their local area networks (LANs).

As was previously mentioned, AUTODIN will eventually be phased out in favor of DMS. Many of the changes will be transparent to the user. The mechanics of either system do not concern the average weather observer. The main point is that you understand the Navy message format.

NAVAL MESSAGE FORMAT

For message traffic to be properly routed to intended recipients, message traffic must be properly formatted. Naval messages are usually composed on desktop computers using specialized message composition programs that assist the user in selecting proper format entries. The software endorsed Navy-wide is known as *Message Text Format (MTF) Editor*. The software assists the user in composing United States Message Text Formatted (USMTF) messages as well as non-formatted messages. The software is menu-driven and allows the user to draft a formatted message by using a "fill in the blank" template. Within each MTF

message are specific blocks of information known as *sets*. Each set begins with the set identifier, followed by a field marker (/). Double slants (//) are used as end-of-set markers. Each set contains only certain information as specified by NTP 3. Some sets are mandatory while others are not. We will discuss the use of each MTF set shortly.

Nearly all messages are formatted by USMTF procedures. The most common type of USMTF message is a General Administrative message, which follows a GENADMIN format. Other USMTF message types include special purpose messages such as CASREP (casualty reports), LOGREQ (logistic requirements), and SORTS (maritime ship reports). Other formatted messages are currently in use by Navy and Marine Corps units, and do not follow the USMTF guidelines, such as the remaining RAINFORM formatted messages, and Movement Reports (MOVREPS). The different types of reports routinely

transmitted by Navy units are discussed in NWP 1-03.1, *Operational Reports*. Instructions for completing USMTF formatted messages and free form messages are outlined in the *Telecommunications Users Manual, NTP 3*.

USMTF messages, free form messages, and other formatted messages all contain a message header and a message body that contains the text or information. Figure 1-12 is an example of an USMTF GENADMIN message.

Message Header

AUTODIN message headers contain several elements that must be included in each header, as well as some elements that are only required on a case-by-case basis. The specific format of a message transmission heading and the routing indicator lines is discussed in JANAP 128, *Automatic Digital Network (AUTODIN) Operating Instructions*.

FORMAT SECTION	EXAMPLE	ITEM
HEADER	PTTCZYUW RULYNMU5678 2391235-CCCC-RULYSUU. ZNY CCCCC P 271020Z AUG 98 FM NAVLANTMETOCCEN NORFOLK VA//N30// TO USS SHIP//JJJ// INFO CINCLANTFLT NORFOLK VA//N5// BT	Transmission ID Classification Precedence & DTG Originator Addressee Info Addee Text separator
BODY OF A USMTF GENADMIN MESSAGE	C O N F I D E N T I A L //N03145// OPER/codename// MSGID/GENADMIN/NAVLANTMETOCCEN/1215/JUL// SUBJ/AVWX (U)// REF/A/DOC/NAVMETOCOM/SEP 96// REF/B/GENADMIN/USS SHIP/270103Z AUG 98// NARR/REF A PROVIDES PRODUCT DESCRIPTION AND REF B REQUESTS PRODUCT BE PROVIDED.// POC/rank and name/command/telephone number// AKNLDG/acknowledge instructions// RMK/1.(U) METEOROLOGICAL SITUATION AT 271200Z: STRONG HIGH PRESSURE CENTERED OVER TRANSIT AREA. 2. (C) 24HR FORECAST FOR PERIOD 271200Z TO 281200Z ALONG TRACK FM 35 00N 075 00W TO 31 00N 070 00W . A. SKY, WEATHER: CLEAR. B. VSBY (NM): UNRSTD. (and so forth. . .) DECL/30JAN99//	Operation Message ID Subject Reference Reference Narrative Point of contact Acknowledgements Remarks-the actual text of the message. Declassification

(CLASSIFIED FOR ILLUSTRATIVE PURPOSES ONLY)

Figure 1-12.—Example of a USMTF GENADMIN message.

TRANSMISSION ID AND CLASSIFICATION.—This data identifies the sending and receiving station routing indicators, and the message sequence number. This data is usually added by the telecommunications center entering the message into NAVCOMPARS, or by the ships communications office. The third group of the top line indicates the Julian date and time of transmission. The fourth group indicates the classification level. The second line of the header is also a classification indicator.

PRECEDENCE AND DTG.—A single letter identifies the message precedence, which is the message delivery time objective. *Z* (flash) means as fast as possible with an objective of less than 10 minutes, *O* (immediate) 30 minutes, *P* (priority) 3 hours, and *R* (routine) 6 hours. The date-time group is normally the UTC date (two digits), time (four digits), three-letter month abbreviation, and two-digit year that the message was released by the originating command. The times 0000Z and 2400Z are not used. Instead, use 0001Z or 2359Z. Keep in mind that certain METOC-related messages must be assigned specific precedence codes. This information can be found in the *United States Navy Meteorological and Oceanographic Support System Manual*, NAVMETOCCOMINST 3140.1.

ORIGINATOR.—After the *FM* designator, the command that originated the message is indicated by a Plain Language Address (PLA) listing, followed by the originating office code set-off within double slants.

ADDRESSEE.—The *TO* portion of the header identifies by PLA, specific commands that must act on the information contained within the message. Instead of, or in addition to, specific commands, the message may be addressed to one or more Collective Address Designators (CADS), or Address Indicating Groups (AIGs). CADS are made up of predetermined lists of commands or communities of like interest. CADS may be as encompassing as *ALCOM*, a CAD for all commands (general messages), or limited to just several commands, such as *OCEANO EAST*, used to send weather observation from ships in the Atlantic Fleet to the Naval Atlantic Meteorology and Oceanography Center in Norfolk and to FNMOC in Monterey. CAD listings for various types of METOC-related messages are listed in NAVMETOCCOMINST 3140.1.

An AIG is defined as an address designator representing a list of specific and frequently recurring combination of ACTION and/or INFORMATION addresses. For example, AIG 76 is used by FNMOC to send message traffic to certain activities concerning

administrative and operational information, as well as notification of outages.

Most of the PLAs and CADs used within the Department of Defense are listed by the Distributed Plain Language Address Verification System (DPVS). The purpose of DPVS is to provide naval message originators *immediate electronic* access to current single and collective PLA information. It is designed primarily to be used with the MTF Editor message preparation program. Updates are sent via BBS, Internet, and record message.

INFO ADDEE.—The *INFO* portion of the header identifies PLAs of commands who need the information provided in the message for information purposes only; no action is required on their part.

EXEMPT LISTING.—If a command normally included in a CAD should not receive a specific message, an exempt listing must be included in the message header immediately following the last action or info addressee. The exempt listing is identified by the abbreviation *XMT*. The PLA for the exempt command follows the *XMT*.

TEXT SEPARATOR.—The text separator is the letters *BT*. This indicates the separation or break between the heading and the body of a message.

CLASSIFICATION AND SSIC.—Although actually apart of the message body, we will consider the classification and SSIC line to be part of the message header since this line must be included in all AUTODIN messages. The classification and SSIC line uses an identical style in all of the various message formats. The message classification is entered on a message by the classification word plus any special handling instructions. The classification is entered either as *UNCLAS*, *CONFIDENTIAL*, *SECRET*, or as *TOP SECRET*, with each letter separated by a space. After the last special handling instructions, the Standard Subject Identification Code (SSIC) is entered, bracketed by double slants. For example, //N03145// is the SSIC for Enroute Weather Forecast (WEAX) messages. SSIC codes are found in *Department of the Navy File Maintenance Procedures and Standard Subject Identification Codes (SSIC)*, SECNAVINST 5210.11.

USMTF GENADMIN Message Body

The GENADMIN format is used for all administrative traffic and most outgoing weather forecast products. Terminal aerodrome forecast (TAF) messages also follow this format when transmitted via

AUTODIN. However, ship observations use a free format. Refer again to figure 1-12. The message body follows a USMTF GENADMIN message format used for an outgoing Aviation Enroute Weather Forecast (AVWX). We use this as an example only. Consult NAVMETOCCOMINST 3140.1 for complete content and examples of USMTF GENADMIN forecast formats. Passing instructions, such as "PASS TO EMBARKED MOBILE TEAM," may be included following the SSIC. Passing instructions are used only for exceptional cases not covered by the use of office codes.

OPERATION OR EXERCISE.—Immediately following the classification line, an optional line is used to indicate that the message concerns a naval or joint exercise, or an actual military operation. The indicator *OPER/*, used for operations, is followed by the operation code word, the operation plan number, the primary operation sub-plan nickname, and the

secondary sub-plan nickname (if used), all set off by slants.

MESSAGE ID.—The USMTF message type abbreviation line, beginning with the set identifier *MSGID/*, is used to identify the message type, such as GENADMIN. It is followed by the message originator's short title, and optionally by the originators serial number, and the month, all set off by slants. The Message ID set is mandatory.

SUBJECT.—The subject line is a mandatory entry beginning with the set identifier *SUBJ/*, and followed by the subject of the text of the message.

REFERENCE.—References, entered following the *REF/* set identifier, are optional. References may be any identifiable message, document, correspondence, conference, meeting, or telephone conversation that is pertinent to the message. Each reference cited must be followed by an *AMPN/*, or amplification data line providing the title of the reference. Figure 1-13

CONFERENCE

REF/A/CON/CDR 82ND AB DIV/20SEP98//

AMPN/AIRBORNE COMMANDERS CONFERENCE, FT BENNING GA//

MEETING

REF/A/CON/COMNAVWEPS CTR/02NOV98//

AMPN/JOINT ORDNANCE WORKING GROUP MEETING, DAHLGREN VA//

DISCUSSION/CONVERSATION (other than by telephone)

REF/A/CON/CINCFOR/11MAR98//

AMPN/BETWEEN MAJ SMITH CINCFOR(FCJ3J) AND CDR JONES USACOM(J36)//

TELEPHONE

REF/A/TEL/COMSPAWARSSYSCOM/08DEC98//

AMPN/TELCON BETWEEN SPAWAR/LCDR SMITH AND NPMOC/LT JONES//

DOCUMENT (publication, instruction, regulation, etc.)

REF/A/DOC/JCS J7/15AUG98//

AMPN/JCS PUB 1-01, CHAP II, PARA 3.//

REF/A/DOC/DOD/14MAR98//

AMPN/DIR 5000.1, SUBJECT: MAJOR AND NON-MAJOR DEFENSE

ACQUISITION PROGRAMS, PG 3, PARA D3.//

LETTER (correspondence, memorandum, E-mail, etc.)

REF/A/LTR/COMNAVMETOCCOM N411/09DEC98/

AMPN/TASKING LTR TO NLMOC, SUBJ: TESS EVAL SER N411/123//

REF/A/LTR/NLMOD PATUXENT RIVER/11NOV98//

AMPN/E-MAIL FROM NLMOC/CAPTSMITH/LT JOHNSON, SUBJ:RAINFALL MEASUREMENTS//

VOICE MESSAGE

REF/A/VMG/NAVY PC188/151232ZNOV98//

AMPN/PIREP RCVD BY NLMOF JACKSONVILLE ON 271.6MHZ//

RECORD MESSAGES (Other than MTF formatted messages)

REF/A/MSG/JCS J7-JETD/240700ZMAR98/ /

AMPN/ALERT ORDER: OPERATION DEAL CARDS (U)//

Figure 1-13.—Examples of GENADMIN references.

CONFIDENTIAL //N03141//
SUBJ: SYNOP WEA OB (U)
BBXX SHIP 01124 99251 70803 41998 03210 10245 20232 30132 40136 54000
70154 80000 22211 00230 20401 30000 40000 50000 80226;
DECL 31MAR99

(CLASSIFIED FOR ILLUSTRATIVE PURPOSES ONLY)

Figure 1-14.—Example of a free form message body.

includes examples of several types of references used in messages. When two or more references are provided, a narrative line, indicated by the identifier *NARR/*, must be included. The narrative line explains the importance of the references. The acronym *NOTAL* (not to or needed by all) is used to indicate that some addressees do not hold the referenced material. The acronym *PASEP* (passed separately) is used to indicate that the reference has been passed separately to some or all addressees of the message.

POINT OF CONTACT.—The set identifier *POC/* indicates the message or information point of contact (POC) at the originating command. The rank and name of the POC is followed by the command name or code, and by the telephone number, all set off by slants. This field is mandatory on all *GENADMIN* messages.

ACKNOWLEDGEMENT INSTRUCTIONS.—If receipt of the message is required in writing or by message, special message acknowledgement instructions may be entered following the set identifier *AKNLDG/*.

REMARKS.—Now look back at figure 1-12. Following the *RMK/* set identifier is the actual text of the message. Numbered paragraphs may be used, but are not required. Be sure to mark paragraphs of classified messages with the appropriate classification symbol.

DECLASSIFICATION.—Declassification instructions must be included on every classified message. This entry is not used on unclassified, *EFTO*, or *FOUO* messages. Insert the date or event (which must be less than 10 years from the origination date of the message). Certain categories of information are exempt from the 1 O-year rule and are indicated with the codes *X1* through *X8*.

While many forecast products transmitted via *AUTODIN* follow the *USMTF GENADMIN* format, certain coded products, such as synoptic ship surface weather observations and ship upper-air observations follow a free format.

Free Format Message Body

The free format message uses the same style header and classification line, but the remaining message body is much simpler (fig. 1-14). Notice that none of the information included in the body is set off in slants. Free form messages may also use a numbered paragraph and lettered subparagraph convention if necessary for clarity. When numbered paragraphs are used in classified free-form messages, a classification marking for each paragraph follows the paragraph number, as shown previously in figure 1-12.

Message Readdressals

A message originator and/or recipient may find it necessary to transmit a message to an activity that has a

RTTUZYUW RULSWCA0032 0020059-UUUU-RHMCSUU
ZNR UUUUU
R 020059Z JAN 98 ZYB
FM NAVPACMETOCEN PEARL HARBOR HI//N31//
TO NAVPACMETOC DET BARBERS PT HI//N01//
BT
RADDR 123456 (Processing sequence number (PSN) of original message)
USS NIMITZ//010030Z JAN 98 (PLA and date/time group of original message)
BT

Figure 1-15.—Example of a message readdressal.

need to know, but which was not an addressee of the original message. This process is called message readdressal. The originator or action addressee of a message may readdress that message to another activity for action or info. Information addressees may readdress a message to another activity for information only. Separate readdressal requests must be made for each message and/or section being readdressed. Figure 1-15 is an example of a message readdressal. The MTF editor program will provide all required fields.

Reduction in Transmission of Message Traffic (MINIMIZE)

When an actual or simulated emergency arises or is anticipated, it may become necessary to reduce the volume of record and/or voice communications by imposing *MINIMIZE* on all military circuits. This action is designed to reduce message traffic during high tempo operations. Only traffic directly related to mission accomplishment or safety of life is considered essential and therefore appropriate for electronic transmission. Even high precedence messages that do not meet this criteria cannot be transmitted during *MINIMIZE*. In most cases, *MINIMIZE* is imposed only for a particular geographical region or operating area. Certain METOC-related messages, such as high wind and high seas warnings, are exempt from *MINIMIZE* as per NAVMETOCCOMINST 3140.1. Weather and oceanographic observations are considered significant and should be transmitted during *MINIMIZE* when any conditions listed in table 1-3 exist.

Table 1-3.—Weather and Oceanographic Conditions Exempting Observation From MINIMIZE

WEATHER OR OCEANOGRAPHIC CONDITION
Wind speeds in excess of 34 knots.
Sea height of 12 feet or greater.
Moderate or heavy precipitation.
Pressure change of 3 hPa or greater within the past 3 hours.
Visibility less than 1 mile.
Oceanographic observations as dictated by current operations.
Volcanic activity producing volcanic ash.

REVIEW QUESTIONS

- Q25. Which subsystem of AUTODIN acts as a security screen for incoming messages?
- Q26. Which computer software is used by the Navy to format electronic messages?
- Q27. What publication outlines procedures for formatting USMTF messages?
- Q28. Where can a listing of METOC-related Collective Address Designators (CADs) be found?
- Q29. What is the fastest way to obtain correct Plain Language Address (PLA) information?
- Q30. When is the set identifier "NARR/" used in a GENADMIN message?
- Q31. Declassification dates are valid for what maximum period?
- Q32. What are the two essential considerations for sending electronic message traffic during *MINIMIZE* conditions?

PMSV RADIO COMMUNICATIONS

LEARNING OBJECTIVES: Recognize the purpose of PSMV. Discuss proper PMSV radio operation procedures and proper voice radio communications protocol.

Pilot-to-Meteorological Service (PMSV) radio transceivers are found at most military aviation weather offices ashore. PMSV is used to relay meteorological information between airfield weather offices and aircraft pilots. Operating frequencies for each site are assigned by the Federal Communications Commission (FCC). PMSV transceivers operate in the VHF and UHF frequency ranges, with assigned frequencies generally around 200 to 400 MHz. The frequencies for PMSV services are listed in the DOD Flight Information Publications (Enroute), IFR Supplements, commonly called *DOD FLIP IFR Supplements*. If an airfield has a PMSV radio, the frequency is listed for the airfield as the *METRO* frequency, under the *Communications* heading.

The radio transceivers are set to operate only on the assigned frequency. Normally only the amplifier unit with an audio speaker and an attached push-to-talk microphone is located within the weather office. The actual transmitter, receiver, and antenna assemblies are

usually located in the base operations radio transmitter room. Base electronics personnel perform maintenance on the equipment.

The amplifier within the weather office is left in the "on" position whenever the station is open. Pilots do not routinely monitor the transmission frequency, but rather turn to the frequency only when they wish to talk to a forecaster or an observer. The only way the weather forecaster can initiate contact with an aircraft is to have the Air Traffic Controller direct the aircraft to tune to the METRO frequency and contact the office. This, however, is rarely done.

When talking to aircraft on the PMSV radio, proper military radio protocol must be used at all times. You must use *prowords* when applicable. Prowords are pronounceable words or phrases that have been assigned specific meanings in order to expedite voice message traffic. No personal conversation or general chitchat is permitted. Proper radio procedures are discussed in detail in Allied Communication Publication (ACP) 125, *Communication Instructions Radiotelephone Procedures*. The following guidelines summarize some of the important information provided in ACP 125. **YOU SHOULD AVOID THE FOLLOWING:**

- Misuse of call signs
- Unofficial conversations
- Excessive repetition of prowords
- Use of plain language in place of applicable prowords
- Unnecessary transmissions
- Identification of unit locations
- Use of profane, indecent, or obscene language
- Transmitting when loud background conversations or noise-levels are present
- Depressing the transmit button before you are ready to talk, or holding the transmitter button after you have finished talking

YOU SHOULD ALWAYS DO THE FOLLOWING:

- Speak clearly, slowly, and distinctly, in a normal, yet strong voice
- Avoid extremes in vocal pitch
- Send traffic in phrases rather than word by word

- Hold the mike 2 to 4 inches from your mouth
- Say individual digits, not the combined number

Table 1-4 contains prowords frequently used in PMSV conversations and their meanings. Use these prowords as necessary.

Your station's call sign is your airfield's name followed by the word *METRO*. NAS Pensacola, for example, is *Sherman Field*, so the PMSV station's radio call sign is *Sherman METRO*.

When contacting a PMSV station, an aircraft will first provide the aircraft's call sign, and then the PMSV station's call sign. For example, "NAVY ALFA GOLF ONE ONE ZERO, SHERMAN METRO." Your reply should be, "THIS IS SHERMAN METRO, GO AHEAD NAVY ALFA GOLF ONE ONE ZERO, OVER." From this point on until the end of the conversation, it is not necessary to repeat your call sign or the aircraft's call sign unless several aircraft are calling or standing by on the frequency at the same time.

Take the aircraft's request for information or the information passed. Use the word *OVER* at the end of each transmission to the aircraft, and then release the mike key. Do not depress the mike key again until the aircraft has finished talking and given you control of the mike by the keyword *OVER*. Use the phonetic pronunciation for each digit in a number, such as "WIND THREE-THREE-ZERO DEGREES," instead of, "WIND THREE-HUNDRED THIRTY DEGREES."

When an aircraft asks for information that is not immediately available, reply "ROGER, WAIT, OUT." Obtain the information, recontact the aircraft by stating your call sign, and then the aircraft's call sign, such as "SHERMAN METRO, NAVY ALFA GOLF ONE ONE ZERO." Pass the information only after the aircraft has responded.

Do not pass weather observation or forecast data by reading the code form. Rather, convert the observation report or forecast to understandable English. You may be brief by prefixing the values with an identifying word, such as *sky*, *ceiling*, *wind*, or *altimeter*. In some cases, you may use common abbreviated words to identify information, such as *temp*, instead of temperature; *dew point*, instead of dew-point temperature; *PA*, instead of pressure altitude; or *DA*, instead of density altitude.

If you find it is necessary to spell out long sections of a narrative, use the following words for the punctuation markings: *comma* (,), *period* (.), *paren* ((),

Table 1-4.—Frequently Used PMSV Radiotelephone Prowords and Meanings

ACKNOWLEDGE	An instruction to the receiver that the transmission must be acknowledged.
ALL AFTER	Reference all of a transmission after the word or phrase given.
CORRECT	What you have transmitted is correct.
CORRECTION	I have made an error and the correct information follows.
FIGURES	Numerals or numbers follow.
I SPELL	The next word will be spelled out phonetically.
OUT	This is the end of the transmission, no reply is expected.
OVER	This is the end of my transmission at this time, your reply is necessary.
ROGER	I have received your transmission satisfactorily.
SAY AGAIN	Repeat the last transmission.
THIS IS	This transmission is from the station whose call sign immediately follows.
TIME	That which immediately follows is the date-time group of the message.
WAIT	I must pause for a few seconds.
WAIT, OUT	I must pause longer than a few seconds and will recontact you by call sign.
WILCO	I have received your signal, understand it, and will comply. Since the meaning of ROGER is included in that of WILCO, the two prowords are never used together.
WRONG	Your last transmission is incorrect; the correct version follows.

unparen (), *slant (/)*, *quote or unquote (")*, *hyphen (- in a hyphenated word)*, *colon (:)*, *semicolon (;)*, and *dash (-)* when used between numbers or letters and numbers. Numbers are always pronounced as follows: ZE-ro, Wun, Too, Tree, FOW-er, Fife, Six, SEV-en, Ait, and NIN-er. Letters are always pronounced, when spelling out a word, by using the ICAO international phonetic alphabet (AL-fah, BRAH-VOH, CHAR-lee, etc.). You studied the international phonetic alphabet in *the Basic Military Requirements* training manual, and a copy is provided on the first or second page of each DOD FLIP IFR Supplement.

Pilots transiting from coastal air stations to U.S. naval ships operating off the coast commonly call via PMSV for updates on the latest observation and forecast for "USS SHIP." Since relating the name of a U.S. naval ship to its location, or even the fact that a certain ship is operating in the area is usually classified, the pilot may not ask for the weather for the ship by name. It is essential that military observers or, at least, the duty forecaster keep informed of the naval ships operating within their area of responsibility (AOR). Additionally, although the weather observations from the ships contain the ship's location and identification, and are

therefore classified, the PMSV operator must have access to the ship's latest observations and TAFs.

The ship's TAF, by itself, is usually not classified since it does not provide the ship's position. Weather observers, even in nonsecure work areas, may obtain and keep a sanitized copy of the ship's observation and forecast handy for ready reference. A *sanitized* copy means that the ship's name, all references to locations, and message routing indicators have been deleted.

When passing U.S. Navy ship weather updates to aircraft via PMSV, do not mention the ship's position or the name of the ship. Also, do not discuss expected arrival time of the aircraft at the ship, since this would give hostile forces a good estimate of the ship's distance from shore. Rest assured, the pilot can find the ship and knows within minutes when his aircraft will be arriving. You may have to read an entire TAF forecast over the radio to prevent giving away the flight duration.

In addition to the communication systems we have just discussed, several communications systems or subsystems are designed especially for shipboard or mobile operations. Some of the systems are intended primarily for environmental communications, while

others are used for several different applications. In the next section, we will first cover shipboard computer networks and workstations, followed by a discussion of SHF satellite broadcasts and HF facsimile broadcasts. We will complete the chapter with a discussion of shipboard HF radio systems.

REVIEW QUESTIONS

- Q33. *What is the purpose of the PMSV?*
- Q34. *What does the proword "WILCO" indicate?*
- Q35. *What would be the proper pronunciation of a wind direction of 250° at 17 knots?*
- Q36. *When relaying a current U.S. Navy ship observation to a pilot over PMSV, what information must not be released?*

SHIPBOARD ENVIRONMENTAL WORKSTATIONS AND COMMUNICATIONS SYSTEMS

LEARNING OBJECTIVES: Identify the components of the Tactical Environmental Support System (TESS). Identify the systems associated with the Navy Integrated Tactical Environmental Subsystem (NITES). Identify the components of the Interim Mobile Oceanographic Support System (IMOSS). Identify the basic functions of TESS and IMOSS.

There have been dramatic changes to shipboard communications over the last several years. The advent of the Internet and other advancements in communications technology have improved connectivity between ships and shore-based facilities. These changes have greatly enhanced the quality of environmental support provided by shipboard Aerographer's Mates. To make the most of these changes, several new environmental computer workstations and communication networks have been, and will continue to be, introduced.

TACTICAL ENVIRONMENTAL SUPPORT SYSTEM (TESS)

Aboard ship, a large portion of your workday will be spent working at one of the Tactical Environmental Support System (TESS) workstations. TESS is a modular, interactive, computer-based system that

collects, processes, analyzes, displays, and disseminates METOC data and products. It has been installed afloat on most major combatant ships, such as aircraft carriers and command ships, as well as ashore at NAVMETOCCOM regional centers and facilities, and at Tactical Support Centers (TSC).

The original version of TESS was developed in the mid 1980s as the first stand-alone environmental workstation and has been the backbone of METOC-related information for the shipboard Aerographer's Mate. TESS has gradually evolved into a complete environmental and communications workstation. In 1990, the TESS (3) system was introduced. It provided a larger selection of meteorological and oceanographic products and was the first system that provided connectivity between ships and shore-based METOC activities. The Shipboard Meteorological and Oceanographic Observing System (SMOOS) was also introduced in conjunction with TESS (3). Since then, technology advancements such as the Internet have made enormous amounts of environmental information readily available. As a result, *TESS-Next Century (TESS-NC)* was introduced in 1997 to take advantage of this technological surge. However, until TESS-NC is fully fielded, an interim system, known as TESS-NC Transition, has been made available to the fleet.

The environmental software programs in TESS are ultimately designed to provide tailored meteorological and oceanographic products, as well as electromagnetic propagation, acoustic, and satellite products. This information is used to provide direct tactical support to naval air, surface, and USW operations. TESS assesses the effects of the environment on fleet platforms, weapons, and sensors. TESS products are designed to be timely, valid, and practical. The analyses and predictions from TESS are based on information obtained from various telecommunications channels as well as on-scene observations. In addition, TESS makes use of radio teletype information, HF and satellite information, scientific models, and historical data. In chapter 2, we will describe some of the TESS software programs and their applications.

TESS-NC Transition

The TESS-NC Transition system consists of several personal computers and accessories. The TESS-NC Transition takes advantage of a variety of Commercial off-the-shelf (COTS) products, hardware, and software. Installation of this system provides added functionality not previously supported by TESS (3), including direct ship-to-ship and ship-to-shore

communications, and data access via INTERNET/NIPRNET/SIPRNET.

TESS-NC TRANSITION HARDWARE.—The physical appearance of TESS varies with the version of the system in use as well as the location of each system. Most TESS-NC Transition systems retain the deck-mounted, shock-isolated equipment cabinets of the TESS (3) as shown in figure 1-16. The individual cabinets need not be located together, but are usually distributed throughout the shipboard METOC office spaces to provide several different workstations. The primary operating system for TESS-NC Transition is Windows NT 4.0. Each TESS-NC Transition system consists of an METOC NT server, a METOC Terminal server, and a METOC workstation. These components are setup as a separate Windows NT domain. The AN/SMQ-11 satellite receiver and a supplemental remote workstation are also interfaced with the system, but are not part of the Windows NT domain.

The METOC NT Server is the primary operator workstation for the TESS NC Transition. It stores all user information and profiles and authenticates all user logons to the network. The METOC NT server consists of a dual Pentium Pro 200 MHz processor with 128 megabyte RAM, a 4.2 gigabyte hard drive, and CD-ROM. The METOC Terminal Server acts as a back-up to the NT server. It operates with a single Pentium Pro 200 MHz processor, with 64 megabyte RAM, a 2.1

Gigabyte hard drive and CD-ROM. This computer is designed without keyboard capability, providing domain services without operator interaction. The METOC Terminal server handles data ingest for SMOOS as well as other external communication lines. It also supports the closed circuit television (CCTV) briefing capability. The METOC workstation acts as a secondary operator workstation and consists of a Cyrix 200 MHz processor. It contains a high-resolution color monitor and a keyboard. One or more color printers are also connected to the TESS-NC Transition system.

TESS-TRANSITION SOFTWARE.—As mentioned, the METOC NT server, the METOC Terminal server, and the METOC Workstation operate by using the Windows NT 4.0 operating system. Each computer is loaded with Microsoft Office and commercial web browsers for the Internet. Numerous other government and commercial software programs are available and will be discussed in chapter 2. *The most important difference from previous versions of TESS is Internet access.* Additional information is provided in the *Supplemental Operator's Manual for the Tactical Environmental Support System Next Century (NC) Transition*, SPAWAR document EE685-HC-SUP-010.

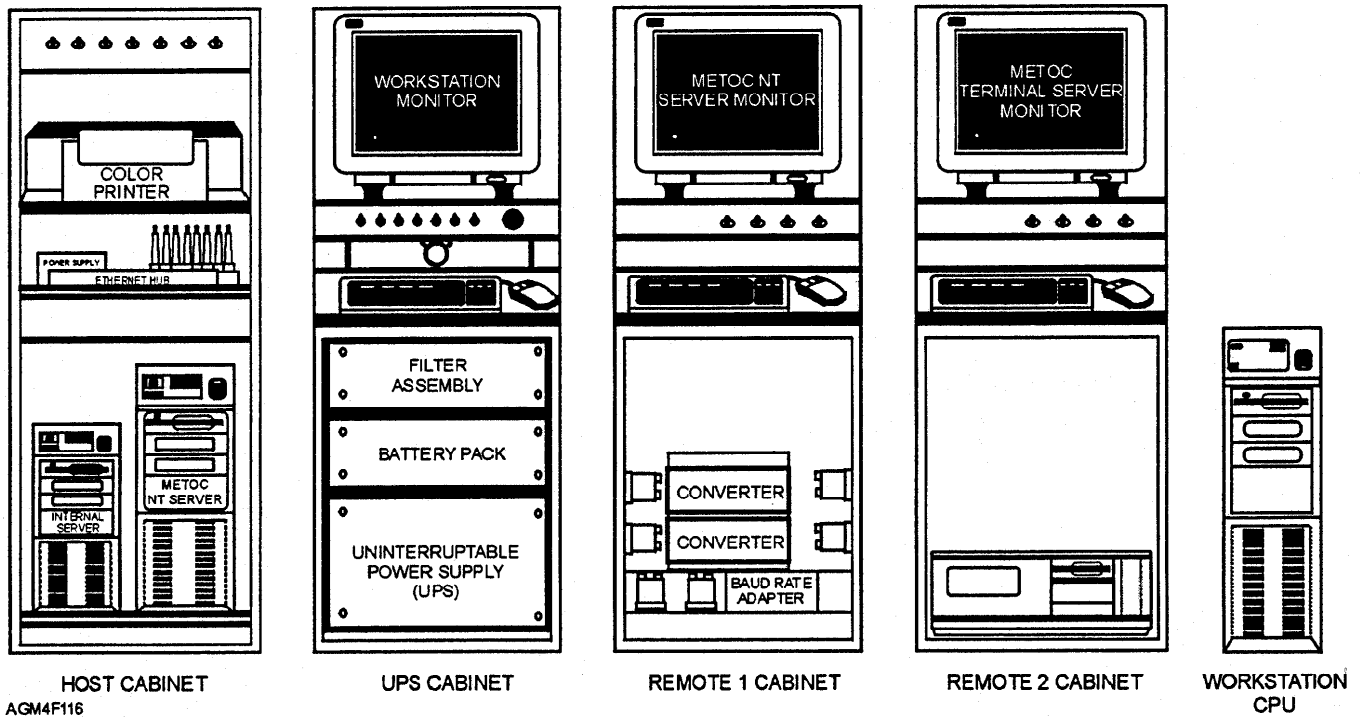

Figure 1-16.—TESS-NC Transition hardware configuration for aircraft carrier METOC office.

TESS-Next Century

The Tactical Environmental Support System-Next Century or TESS-NC is the latest in a series of scheduled changes to shipboard (as well as shore-based communications) for the next century. The vision for this system is to provide easy access not only to a wide range of data from various sources, but also to interface with remote systems to access a variety of environmental applications programs. TESS-NC will provide a METOC database containing climatological data, on-scene environmental measurements, and numerical forecasts. TESS-NC will have the capability to produce analyses and forecasts, to support weather briefings, and also provide tactical decision aids. The goal is to provide maximum flexibility to support the individual needs of each site.

As of this writing, the final configuration of TESS-NC is not available. TESS-NC will retain the basic configuration of the TESS-NC Transition, but will be equipped with more powerful computer processors. It will consist of at least three PC workstations using 300 to 500 MHz Pentium processors. Each of these workstations will have SIPRNET access. An unclassified workstation, operating with a 300 to 500 MHz Pentium processor, will be used for NIPRNET

access, HF facsimile download, and connection to the ship's LAN. A standard 166 MHz laptop with SIPRNET access is also included. Additionally, TESS-NC will have a Unix-based server and workstation for access to the Global Command and Control System-Maritime (GCCS-M). The system will also have connectivity to the SMQ-11 (fig. 1-17). Software for TESS-NC is discussed in chapter 2.

TESS-NC is actually included with several METOC-related support systems under the umbrella of the Navy Integrated Tactical Environmental Subsystem (NITES). NITES incorporates five major subsystems identified as NITES I through V (fig. 1-18). NITES I will be the classified local data ingest center and principal METOC analysis and forecast system. NITES I is in fact another designation for the TESS-NC. NITES II is the METOC-related software segment found on the Global Command and Control System-Maritime (GCCS-M). NITES II is actually a classified network that will provide access to a distributed METOC database via a GCCS-M Unix workstation. NITES III is the *unclassified* forecast, briefing, and display system tailored to Naval METOC shore activities in support of aviation operations. This system will be the eventual replacement for the MIDDS, which was discussed earlier in the chapter. NITES IV is the

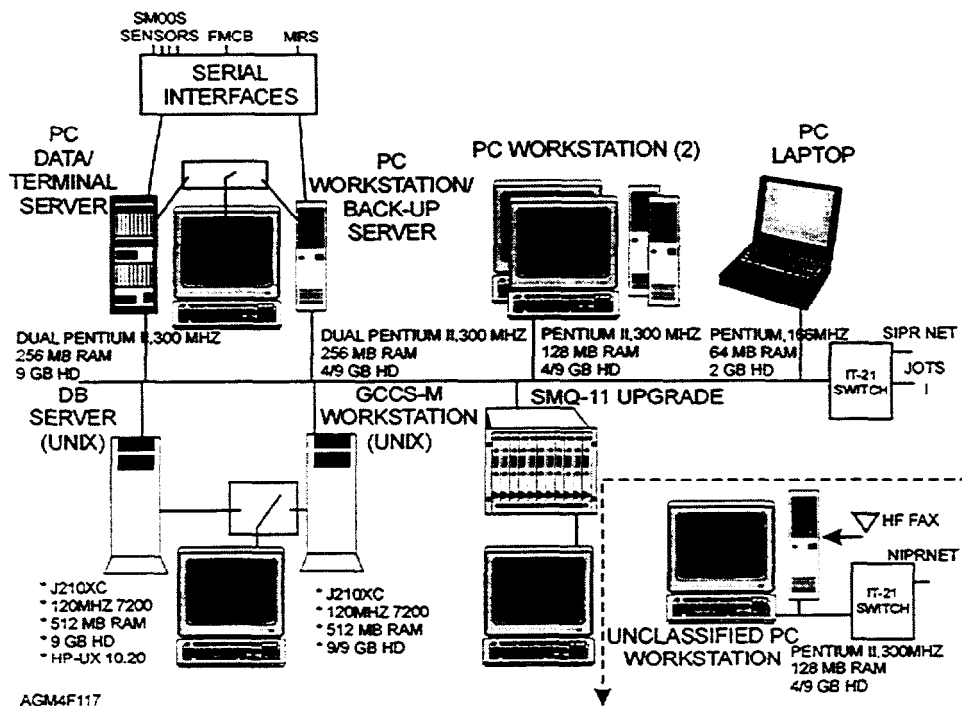

Figure 1-17.—TESS-NC hardware configuration for afloat units.

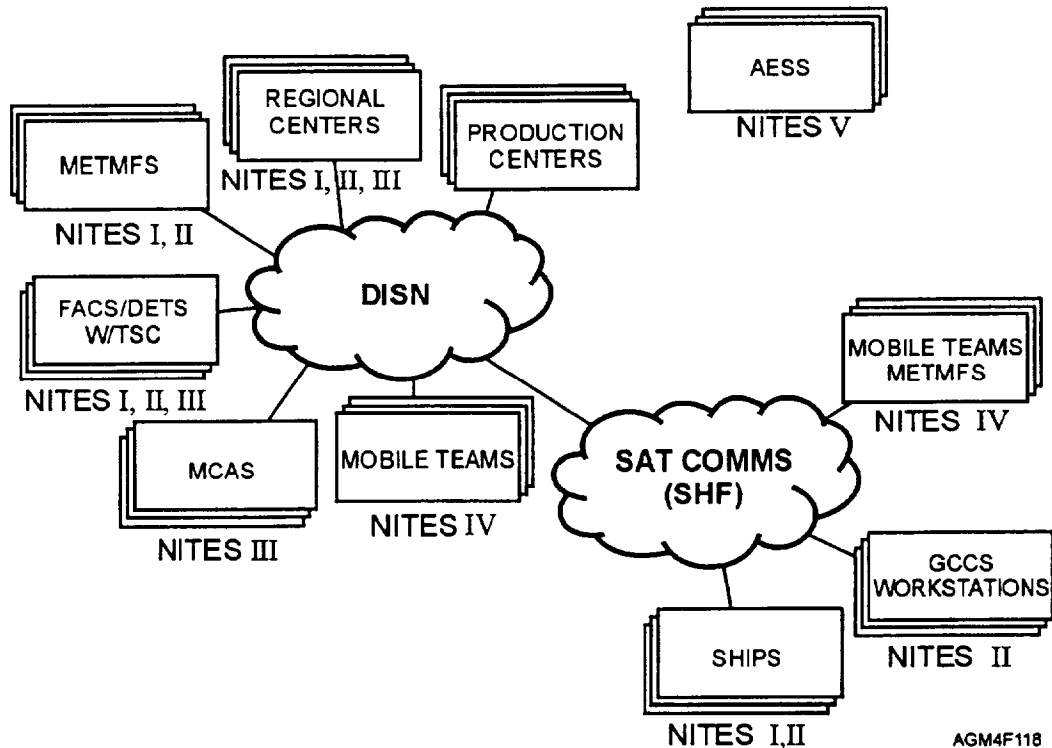

Figure 1-18.—Concept of NITES I through V supporting METOC sites.

portable environmental system tailored to mobile METOC support that includes members of mobile teams and Marine Corps mobile support units. This system will ultimately replace the Interim Mobile Oceanography Support System (IMOSS). NITES V is the Allied Environmental Support System (AESS).

INTERIM MOBILE OCEANOGRAPHIC SUPPORT SYSTEM (IMOSS)

The Interim Mobile Oceanography Support System (IMOSS) is a modular, rapid-response, on-scene environmental prediction computer system. It is a lightweight system based on network technology and laptop computers. IMOSS is primarily used by Navy Mobile Environmental Team (MET) members and Marine Corps Meteorological Mobile Facility (METMF) members. This system can store, analyze, and process meteorological and oceanographic information and produce numerous METOC application products.

System Configuration

The IMOSS consists of three sub-systems: the main subsystem, the communication sub-system, and the satellite sub-system. Each sub-system can be used as a

stand-alone system, depending upon mission requirements. Network Interface Cards (NIC) included in each sub-system allow them to be networked together for easy file transfer and data communications. The ability to network also allows the IMOSS user to tie into Local Area Networks or Wide Area Networks to obtain products and data from remote sources. Details on IMOSS as well as instructions for LAN and WAN connectivity can be found in the *Interim Mobile Oceanography Support System (IMOSS) Users Guide*, published by the Naval Oceanographic Office and delivered with each system. Figure 1-19 shows the basic IMOSS LAN configuration.

Main Module

The main module is designed to be used primarily for briefing support and the production of products from the GFMP suite of software. The main module consists of a laptop computer, a classified, removable hard drive, and network interface devices. The current laptop computers include either an IBM 760EL(U4G) Thinkpad or a NEC VERSA 6030H Notebook. Both have a 133MHz Pentium processor, CD-ROM drive, and floppy drive capacity. These systems run using the Microsoft NT operating system and are loaded with Microsoft Office. Older systems operate on an IBM

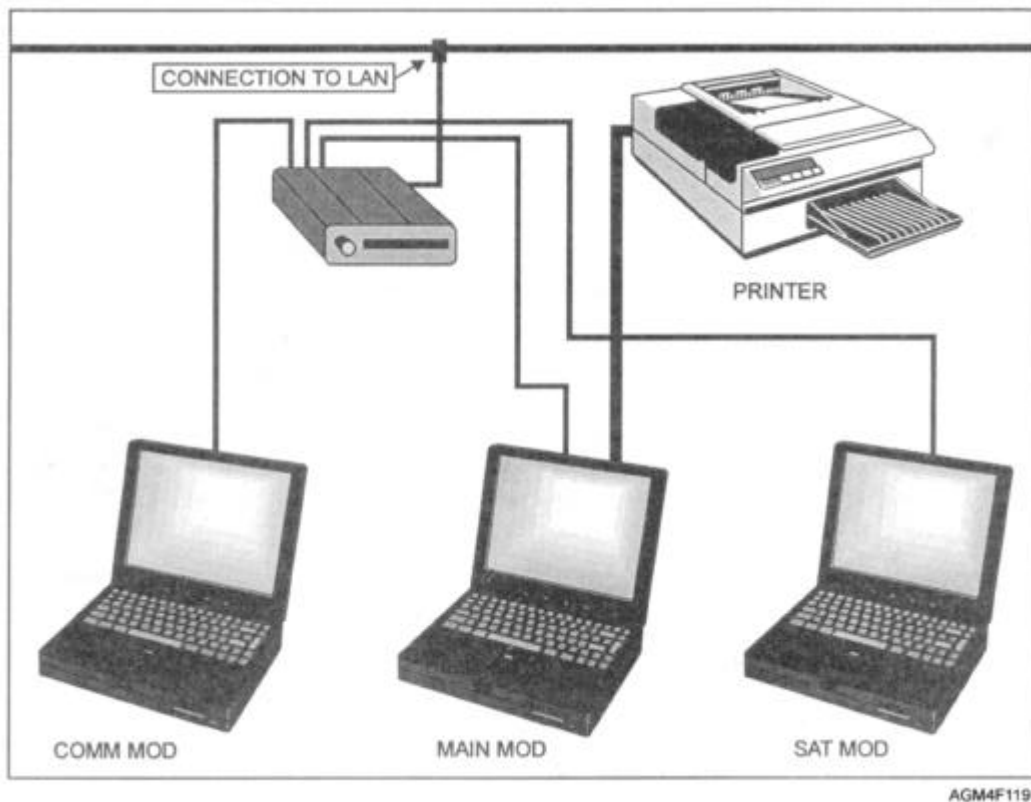

Figure 1-19.—Basic IMOSS LAN configuration.

755CD Thinkpad, which uses a 486DX4 100 MHz processor and the Windows 3.11 operating system. All components are packed in ruggedized cases.

The GFMPL software is loaded via CD-ROM. Both a classified and an unclassified version are available. GFMPL provides four basic functions: environmental data assimilation, environmental data analysis, sensor detection range and coverage predictions, and data file maintenance. GFMPL will be discussed in detail in chapter 2 of this module. Keep in mind that when the classified version of GFMPL is operating with any of the IMOSS computers, that computer, as well as any other attached devices or networks, must be classified at the appropriate level. When using the IMOSS in a network, you must take precaution to ensure that classified data is not inadvertently transmitted or made available to unauthorized sources.

Communications Module

The purpose of the communications module (COMM MOD) is to receive alphanumeric weather data and facsimile broadcast data via the HF receiver or satellite (fleet environmental broadcast data) using shipboard communications facilities. The receiver of the module has the capability to connect to the host ship's antenna system or be deployed independently with its own antenna. Currently, the communications sub-system consists of either an IBM 760EL (model U6F) or an NEC VERSA 2430CD notebook computer. The system also consists of a Kenwood R-5000 HF radio receiver or a Drake R8A communications receiver. It also includes a Dymek DA100D Tuner/Power supply receiving antenna and/or a Dymek DA 100E all-wave receiving antenna and various interface devices.

The Weather Fax system for Windows (version 3.0) is a software program that is preconfigured to run on the COMM MOD. It works with Windows NT and can operate even while other programs are running. Weather Fax is used to copy HF facsimile products and requires that a demodulator be used to interface with the HF receiver. The program can be used to tune the receiver and format a facsimile reception schedule. A Weather Fax scheduler database allows you to browse through selected world weather fax stations and schedules. The COMM MOD can also be configured to receive RATT (Radio Teletype) directly from a shipboard patch panel. RATT data is basically AWN data received from the Fleet Environmental Broadcast. RATT data can be saved in an ASCII format. Detailed setup and operating instructions for the COMM MOD are contained in the *IMOSS Users Guide*.

Satellite Module

The purpose of the satellite module (SAT MOD) is to receive, store, and display data from meteorological satellites. Like the communications module, the satellite module is another separate laptop computer that is packaged in a separate ruggedized case. Automatic Picture Transmissions (APT) data from polar-orbiting satellites, as well as WEFAX imagery from geostationary satellites, can be received depending on the antenna selected. The received data is ingested and managed by software known as WEATHERTRAC. The SAT MOD can be linked to the COMM MOD and to the main MOD to provide data transfer and briefing support, or it may be deployed independently. The satellite module is discussed in detail in chapter 1 of module 3. Setup and operating instructions are contained in the *IMOSS Users Guide*.

REVIEW QUESTIONS

- Q37. *What is the main function of TESS?*
- Q38. *What is the major difference between older versions of TESS and TESS-NC Transition?*
- Q39. *The TESS-NC Unix-based workstation is used for what purpose?*
- Q40. *How many environmental subsystems does the NITES incorporate?*

- Q41. *IMOSS is primarily designed for what segment of METOC support?*
- Q42. *Which module of IMOSS is designed primarily to run GF MPL?*
- Q43. *What is the purpose of the IMOSS communications module?*
- Q44. *What type of satellite data can be copied by using the Satellite Module?*

SATELLITE AND HIGH-FREQUENCY FLEET BROADCASTS

LEARNING OBJECTIVES: Recognize the various SHF satellite and HF radio broadcast systems used to transfer environmental information to ships and mobile environmental teams, Identify the publication that lists HF radio environmental broadcast channels. Describe HF facsimile receiver equipment used by Aerographer's Mates.

In this section, we will discuss the various super-high-frequency (SHF) satellite and high-frequency (HF) radio environmental broadcasts that are available to Aerographer's Mates stationed aboard ship or assigned to mobile teams. We will also discuss HF facsimile receiver equipment.

FLEET MULTI-CHANNEL BROADCAST (FMCB)

Shipboard Aerographer's Mates routinely send all observations and forecasts from their ship to other units via AUTODIN. They also receive and send a number of administrative messages via AUTODIN channels during normal operations. The bulk of incoming meteorological and oceanographic data is received on a satellite broadcast known as the Fleet Environmental Broadcast. Both AUTODIN and the Fleet Environmental Broadcast are transmitted to ships via SHF satellite as part of a secure communications system known as the Fleet Multi-channel Broadcast (FMCB).

Unclassified information from the AWN is forwarded to selected naval communication stations for broadcast via satellite. Each Naval Meteorology and Oceanography regional center monitors the environmental broadcast for their AOR (see table 1-5). The contents of each broadcast are also determined by each regional center. Normally, any data available in the AWN may be included on the environmental broadcast. However, because of the limitations of the system, only selected data are actually included. The regional centers may send a command via an AFMEDS terminal to halt the stream of data sent by the AWN. During these halts, classified traffic is transmitted by the regional center to the communications station for retransmission directly on the environmental broadcast. This classified data typically consists of naval ship observations and forecaster meteorological assistance support (MET Assists).

Specific requests for observations or forecasts not included in the broadcast are sent via message to the Fleet CINC and the responsible regional center with an information copy to COMNAVMETOPCOM, as specified in NAVMETOPCOMINST 3140.1. Your LCPO or MET Officer will normally initiate these requests.

The content of the environmental broadcast, as well as the channel assignments and the actual communications satellite itself, shifts when naval ships transit from one operational command area to another. Ships usually encounter these shifts when transiting from the Atlantic into the Mediterranean, from the Red Sea into the Arabian Sea, and through the Panama Canal.

The FMCB is normally transmitted in encrypted form. Aboard ship, the Radiomen operate and monitor the FMCB receiving equipment and crypto equipment. The decrypted data stream from the Fleet Environmental Broadcast is transferred to the shipboard weather office on a protected circuit. In the weather office, the data may be directed to a TESS or IMOSS terminal, or directly to a printer.

Other channels of the FMCB support AUTODIN message service and tactical data that supports systems, such as the Joint Operations Tactical System (JOTS), the Officer-in-Tactical Command Information Exchange System (OTCIXS), or the Tactical Data Information Exchange System (TADIIXS). Many environmental products are composed specifically for these systems. The JOTS system in particular is extensively used by USN MET and USMC METMF members when embarked aboard ships without a weather office. The shipboard Aerographer's Mate normally has no responsibility to operate the shipboard receiving equipment for the JOTS, OTCIXS, or TADIIXS broadcasts.

HIGH FREQUENCY (HF) BROADCASTS

Many meteorological and oceanographic data broadcasts containing either alphanumeric or graphic (facsimile) information are available for ships at sea from HF radio transmissions in different parts of the world. In the past, the National Weather Service, the U.S. Air Force, and NAVMETOC regional centers transmitted a continuous HF broadcast of meteorological data. Due to the high maintenance cost and advancements in communication technology, most of these broadcasts have been reduced or have been eliminated altogether.

Table 1-5.—Fleet Environmental Broadcasts Monitored by NAVMETOPCOM Regional Centers

NAVMETOPCOM CENTER	BROADCASTS MONITORED
NLMOC Norfolk (2nd Fleet)	East Atlantic: LMHA West Atlantic: LMHB NATO: H52N
NEMOC Rota (6th Fleet)	Mediterranean: MMHH
NPMOC Pearl Harbor (3rd Fleet)	East Pacific: PMOO
NPMOC WEST Guam (5th/7th Fleet)	West Pacific: PMHH Indian Ocean: MMWW

Air Force High Frequency Regional Broadcasts

In the late 1980s, with the loss of the NWS meteorological alphanumeric and facsimile HF radio broadcasts, the Air Force initiated a High Frequency Regional Broadcast (HFRB) program to transmit alphanumeric information from the AFWA and graphic products from AFWA on several regional broadcasts. These broadcasts are available and compatible with Navy shipboard receivers. Either alphanumeric or graphic data may be directed to the TESS or IMOSS systems. Alternatively, alphanumeric data may be directed through a converter to a shipboard teleprinter, and the graphic data directed to a facsimile recorder.

These broadcasts carry AFWA regional graphic products on the upper sideband of the listed frequency and AFMEDS alphanumeric regional information on the lower sideband of the frequency. Broadcast frequencies and transmission times are available from the *Worldwide Marine Radiofacsimile Broadcast Schedules* published by the Department of Commerce/NOAA. This publication lists worldwide transmissions of meteorological and oceanographic products. Few observational data broadcasts are listed since these are not designed for use by the average mariner. Products are listed by the scheduled UTC transmission time of the product. HFRB sites broadcast only one frequency at any given time with routine frequency shifts at sunrise and sunset at the transmitter site. The broadcast is normally unencrypted, but may be encrypted for special Air Force support. When tuning a receiver to copy the sideband transmissions, you must tune your receiver 1.9 kHz higher than the listed frequency for an upper sideband (USB) signal and 1.9 kHz lower for a lower sideband (LSB) signal.

There are three active HFRB broadcast sites currently operational: a United States HFRB site at Elkhorn, Nebraska; a European HFRB site at Croughton, England; and a Caribbean and Central American HFRB site at Roosevelt Roads, Puerto Rico.

U.S. Navy Fleet Broadcasts

NAVMETOC regional centers still have HF facsimile broadcast capability that may be used as a backup source for meteorological data aboard ship. Navy Mobile Environmental Teams and Marine Corps METMF van sites may copy HF broadcasts as their primary data source when routine fleet meteorological communications are not available. However, these HF broadcasts are activated on a contingency-on-request

basis only. Special request for activation of a particular HF broadcast must be sent to the appropriate NAVMETOC regional center.

The content of the HF broadcast is controlled by each NAVMETOCCOM regional center to provide support for U.S. Navy units operating within their AOR. Most products are computer-generated graphics of surface and upper-air analysis and forecast products. The data signals for the graphic products are sent from the regional centers to naval communications stations via landline. The communications station then transmits the signal on HF radio. Transmission frequencies and the broadcast time of each particular product are available by mail from each regional center, and are also included as part of the broadcast.

U.S. Coast Guard Facsimile Broadcast

The U.S. Coast Guard transmits a high-frequency facsimile broadcast of National Weather Service charts and satellite imagery. Broadcast stations include San Francisco, New Orleans, Boston, and Kodiak. Schedules and frequencies are available via the Internet. As with other HF meteorological transmissions, a listing of broadcast frequencies is available in the latest edition of *Worldwide Marine Radiofacsimile Broadcast Schedules*.

Foreign HF Broadcasts

Many meteorological and oceanographic data broadcasts containing either radio teletype or facsimile information are also available by copying HF radio transmissions from different countries of the world. U.S. Navy ships conducting an exercise or operation in a particular area may require more detailed meteorological information than is available on the Fleet Environmental Broadcast or regular military HF facsimile broadcasts. You may have to tune into a foreign HF radio meteorological broadcast and copy all of the information that country is willing to share with the rest of the world.

Two publications are very useful in determining the frequency and content of the various indigenous broadcasts. We have already mentioned the *Worldwide Marine Radiofacsimile Broadcast Schedules* publication. Another useful publication for meteorological or oceanographic data collection is Air Force Manual 100-1, *Global Weather Intercepts*. A portion of this publication lists meteorological broadcast frequencies and transmission times grouped according to the type of broadcast-continuous wave (CW), RATT, or facsimile-region, country, and transmitter site.

HF Facsimile Recorders

As a weather observer, you may be tasked to copy HF facsimile products by using miniaturized facsimile (minifax) recorders. Normally, several different frequencies are available for each HF broadcast station. A few of these frequencies are available 24 hours per day. You must monitor the signal to ensure that usable quality graphics are produced. Due to daily changes in atmospheric conditions, you will find that lower broadcast frequencies provide a better signal at night, while higher broadcast frequencies provide a better signal during the day.

Most U.S. originated HF radio analog signal facsimile transmissions include a marking tone at the beginning of each line of the image. This marking *tone* is automatically interpreted by the recorder to indicate a new line of image, and the recorder automatically aligns each line properly to form the image. Some foreign facsimile transmissions do not contain a recognizable marking tone, which results in a skewed image where each line of the image is offset an inch or two to the right or left. Manually setting the recorder LPM-setting to match the transmission LPM setting normally corrects the skew. Common settings used are 60-, 90-, 120-, or 240-lines-per-minute.

Two models of minifax's are in use by Navy MET and Marine Corps METMF units: the 9315 series TR4 and the TRT models. Both are equipped with a 5-foot whip antenna and preamplifier for *use* aboard ship or ashore. Aboard ship, the ship's antenna system may be connected to the recorder instead of the 5-foot whip.

The Alden 9315 series facsimile receiver/recorders contain a digital receiver and use dry, thermally sensitive 1 1-inch-wide rolls of paper. Replacement rolls of paper are inserted through the top of the equipment following instructions provided inside the paper compartment. A forward and reverse scanning thermal print head is used instead of a stylus on a belt. You must be very careful when feeding the paper through the roller system to avoid damaging the thermal print head.

ALDEN 9315 TR4.—This minifax is widely used by mobile teams. The TR4 model can copy facsimile transmissions received over the internal receiver, over an external radio, or over the telephone. AM voice broadcasts and CW may be monitored on a speaker. A 9315 TR4 is shown in figure 1-20.

ALDEN 9315 TRT.—Although the TRT model looks nearly identical to the TR4 model, it is much more than a facsimile receiver/recorder. The 9315 TRT has a

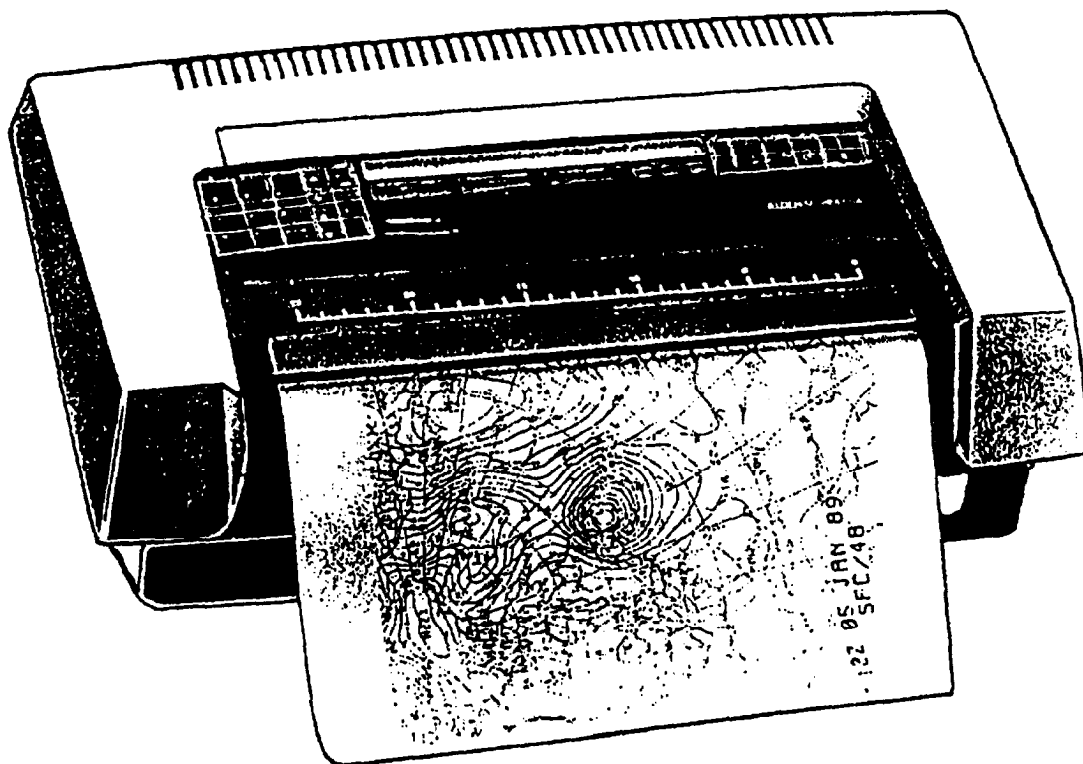

AGM4F120

Figure 1-20.—Alden 9315 series TR4 model facsimile receiver/recorder.

SHIPBOARD HF RADIOS

built in signal converter in addition to the receiver. The equipment is capable of printing digital facsimile graphics, HF radioteletype, and CW decoded from International Morse Code into alphanumeric characters. Other than tuning the proper radio frequency and setting the AM/USB/LSB/FM switch, no additional operator inputs are necessary to print alphanumeric data, graphics, or imagery.

For use ashore, an optional long-wire antenna or the whip antenna may be used. The long-wire antenna has two very long lengths of reinforced wire extending from a central connection point. Although this antenna receives signals very well, it must be lowered from its installed location and tuned by shortening or lengthening the two wires for each different frequency range. Frequency range markings are provided on each wire. Detailed instructions are provided in an instruction booklet supplied with each long-wire antenna.

REVIEW QUESTIONS

- Q45. *How is the Fleet Environmental Broadcast and AUTODIN traffic relayed to ships at sea?*
- Q46. *Which NAVMETOC regional center is responsible for the Sixth Fleet Environmental Broadcast?*
- Q47. *What type of data is included in the Fleet Environmental Broadcast?*
- Q48. *Which agency maintains high frequency regional broadcasts (HFRB)?*
- Q49. *What is the purpose of the HF facsimile broadcast from NAVMETOC regional centers?*
- Q50. *Which publication contains listings of frequencies for HF RATT and facsimile transmissions?*
- Q51. *What level of HF frequencies should be copied at night?*
- Q52. *Which type of facsimile recorder is the most widely used by mobile environmental teams?*

LEARNING OBJECTIVES: Identify the radio communications equipment routinely found in shipboard weather offices. Discuss the applications and use procedures for this equipment.

Aboard ship, weather observers may be tasked to operate special radio-receiving equipment to tune in local HF environmental broadcasts of alphanumeric or facsimile products. With the advent of TESS (3) and subsequent advancements in communications technology, copying an HF radio broadcast with this equipment is rarely necessary. In this section, we discuss some basic terms that you must be familiar with, basic shipboard radio receiving equipment you might use, and the information systems that are used aboard ships to receive environmental information.

The equipment you will use to receive I-IF radio transmissions aboard ship varies for the different types of broadcasts. Weather personnel are primarily concerned with receiving voice broadcasts, Radioteletype (RATT) broadcasts, and facsimile broadcasts. To receive a radio voice broadcast, all you need is an antenna, a radio receiver, and a speaker. On most ships, these are all separate pieces of equipment. To copy a facsimile broadcast, you will need to patch the output from the radio receiver into a facsimile recorder. Finally, to receive a RATT broadcast, you will need to patch the output from the radio receiver into a signal converter, then patch the converter output into a teleprinter. Aboard ship, antenna patch panels and transfer switchboards are used to connect various pieces of equipment.

HF ANTENNAS

Aerographer's Mates and Marine Corps observers use antennas both ashore and shipboard to receive HF radio transmissions of weather information and satellite broadcasts. Fortunately, many of the meteorological or oceanographic data reception systems in use have been simplified so that the antenna that is supplied with the system matches the frequencies desired. Aboard ship, antenna usage is controlled by the Radiomen in the communications spaces. Before attempting to tune in a

frequency, consult with the duty radiomen for the best available antenna to use to receive the desired broadcast. Aboard CVs, LHAs and LHDs, several shipboard antennas may be dedicated for use by the weather office. When dedicated antennas are present, one or more AN/SRA-12 antenna patch panels will be located within the Met Office (fig. 1-21).

On the AN/SRA-12, the top row of jacks may contain plug connections to either antennas or receiver sets. In figure 1-21, two antennas are available: INT ANT-2 and a LONG WIRE; and four radio receivers: R-2368 No.5, No.6, No.7, and No.8. The lower portion of the panel contains an antenna-input patch (on the far-left side), and four patches for each of the seven filtered frequency ranges varying from 32 MHz down to 14 kHz. ANT-2 has been selected as the input antenna and connected to the input jack. R-2368 No.5 has been patched to the filtered antenna output in the 32 MHz to 14 MHz range.

NOTE: When patching, you must always insert the end of the antenna patch cord into the receiver first, and then into the lowest usable filtered frequency patch. When unpatching, remove the receiver jack first, and then the filtered frequency patch. Patch or unpatch from the top down.

More than one receiver may be connected to the same antenna. For instance, receiver No.6 may be connected by use of an additional patch cord to another jack on the filtered 32 MHz to 14 MHz output or to another frequency range.

RADIO RECEIVERS

There are two basic types of radio receivers found in shipboard meteorological offices: the R-1051/URR receiver and the newer R-2368/URR. The R-2368/URR is currently being installed in all new construction ships, and is being retrofitted to older ships to replace both the R-1051/URR medium- and high-frequency receivers and AN/WRR-3 low-frequency receivers.

R-1051/URR Receiver

The R-1051/URR receiver (fig. 1-22) receives CW, AM, USB, LSB, and ISB signals, plus frequency-shift keying (FSK) signals in the 2-MHz to 30-MHz range. Frequency settings are dialed into the windows on the front panel. This receiver is a very reliable receiver and is very easy to operate. Operator instructions and very simple operator maintenance procedures are contained in the operator's manual for the R-1051(B), (C), or (D)/URR Receiver.

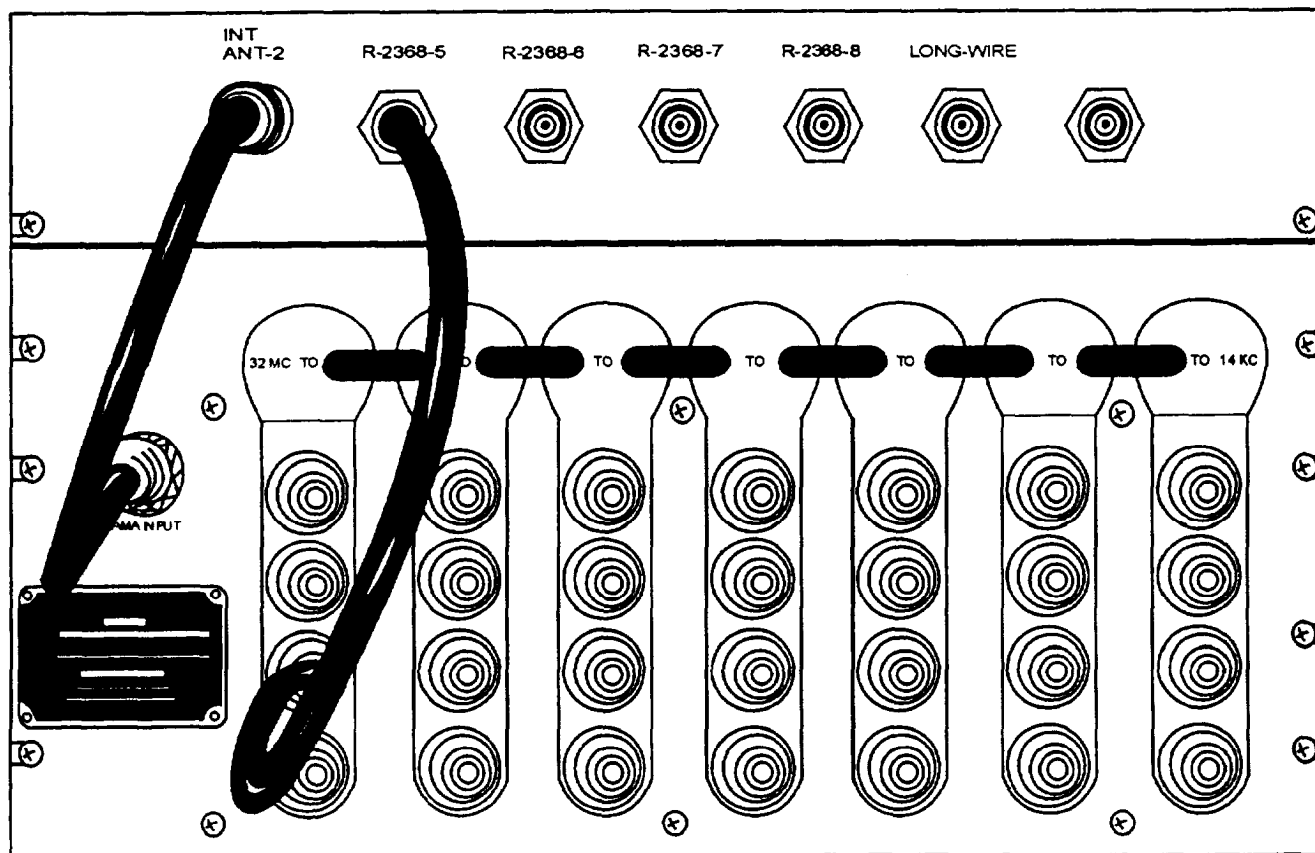

AGM4F121

Figure 1-21.—AN/SRA-12 antenna filter and receiver antenna patch panel.

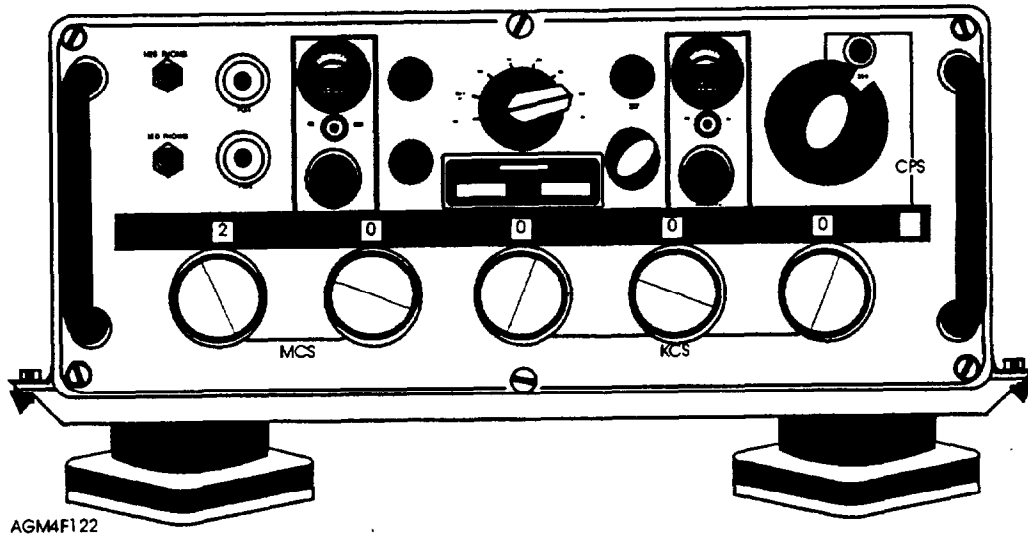

AGM4F122

Figure 1-22.—R-1051(B)NRR receiver.

R-2368/URR Receiver

Figure 1-23, view A, shows the R-2368/URR receiver ready for mounting in an equipment cabinet;

view B shows the front panel. The R-, medium-, and high-frequency communications. The equipment is capable of receiving in the USB, LSB, ISB, AM, FM, and CW modes. It has a unique frequency-

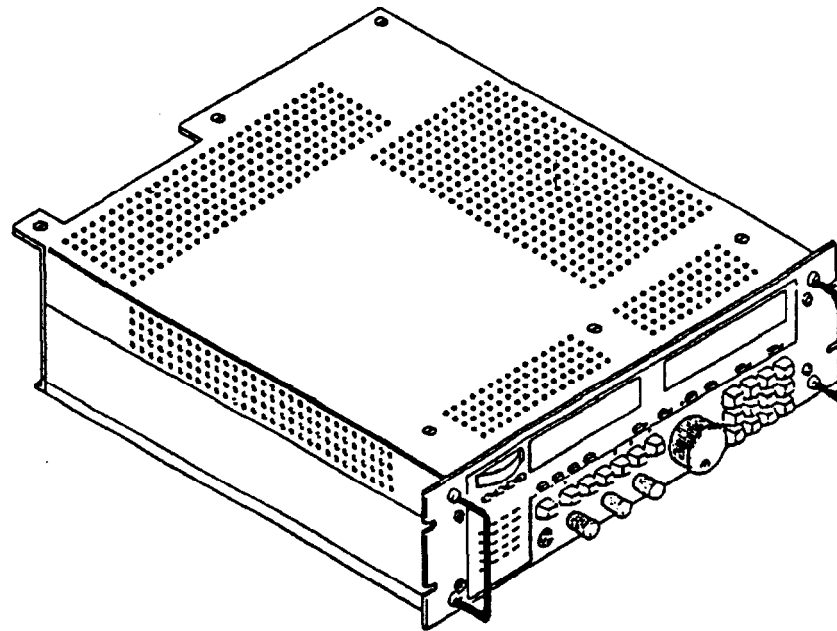

A. R-2368/URR RECEIVER

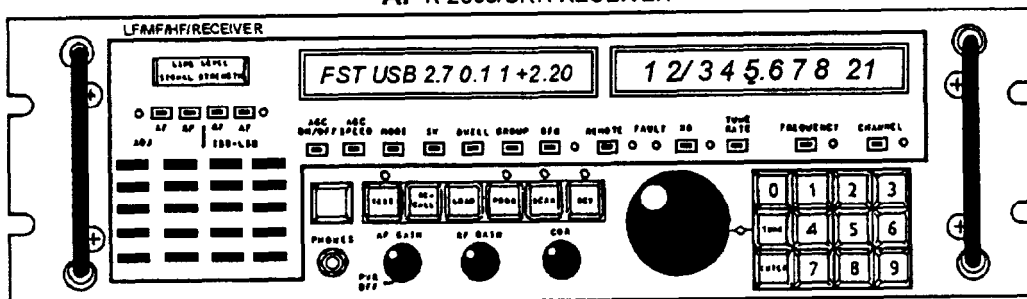

B. FRONT PANEL

AGM4F123

Figure 1-23.—R-2368/URR receiver.

programming feature that can store up to 100 preprogrammed frequencies. A keypad is used to key in frequencies either for use or program storage. The receiver may scan any or all of the preprogrammed frequencies to check for traffic on the frequency.

Operator maintenance is limited to scheduled cleaning, visual inspection, and initiating a periodic self-test routine. No special training or equipment is required. The front panel should be checked once a day for display of a fault condition to ensure that there is no internal circuitry failure. Details of these operator maintenance procedures, as well as easy to follow operator instructions, are contained in *Technical Manual Operation and Maintenance Instructions with Parts List, Receiver R-2368/URR, EE125-FC-OMI-010/R-2368/URR*.

RECEIVER SWITCHBOARD

The receiver transfer switchboard allows you to transfer the audio output from the receivers to remote control station audio circuits. Figure 1-24 shows two representative SB-973/SRT receiver transfer switchboards. These switchboards contain ten 7-position switches. Each switch is connected to a remote station, such as a facsimile recorder, the TESS input jack, or an audio speaker. Each of switch positions 1

through 5 relates to a receiver, which is usually specified on an engraved plate along the top of the switch case. In figure 1-24, only the first four switches of each switchboard have been used, as seen by the engraved equipment identification adjacent to each switch. The position "x" on each switch allows you to transfer the circuits to additional switchboards.

AN/URA-17 COMPARATOR-CONVERTER

A comparator-converter device is used to convert a radio receiver's frequency shift keying audio output carrying radioteletype information into direct current (dc) pulses compatible with a teleprinter. The comparator-converters currently used aboard Navy ships are the AN/URA-17(B) or (C) versions (fig. 1-25). A group consists of two CV-483/URA-17 frequency shift converters cross connected with a wiring harness. The output of each CV-483 is hardwired into receiver transfer switchboards, and usually identified as URA-17 "A" for the top converter, and as AN/URA-17 "B" for the bottom unit.

Two converters are supplied so that the user may tune in the same radioteletype broadcast on two separate frequencies with two radio receivers, and feed the output from both converters into the same printer. This method of copying a radioteletype broadcast is

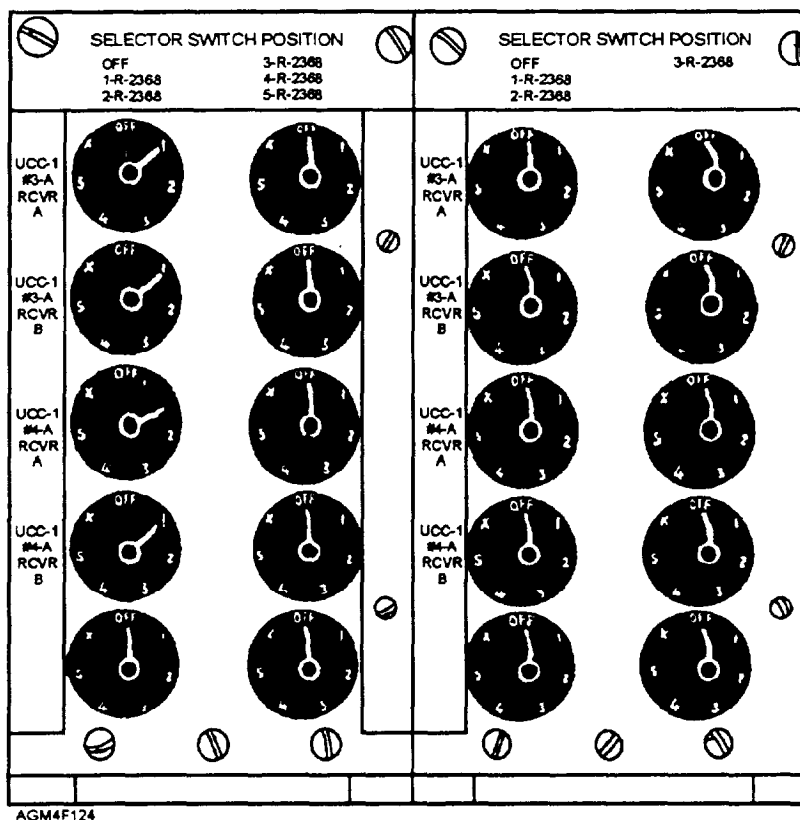

Figure 1-24.—SB-973/SRT receiver transfer switchboards.

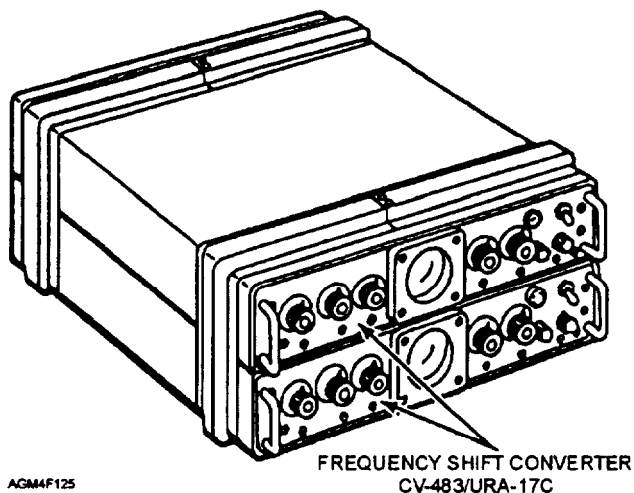

Figure 1-25.—Comparator-Converter group AN/URA-17(C).

called *diversity*. When the URA-17 is operating in diversity mode, the signal comparator circuits in the equipment compare the signal strength and clarity of each received signal, and allow only the better signal to be routed to a printer.

Each converter may also be used independently. When you operate a CV-483 in the single mode, the comparator circuits are not used. Separate radioteletype broadcasts may be routed through each converter and sent out to separate printers. Operation of

each individual CV-483 is not difficult. Operator controls are all on the front of the unit (fig. 1-26).

In order to successfully copy RATT data, you must complete the following steps:

1. Using switchboards and antenna patch panels, connect an appropriate antenna to your receiver(s), and then connect your receiver(s) to the CV-483(s). Optionally, you may also patch radio output to an audio speaker. A RATT signal has a distinctive sound. With experience, you may be able to properly tune a RATT signal by sound alone.

2. Turn the power on with the power switch, and then place the function switch to the "tune" position.

3. Then tune a radio receiver to a listed radioteletype frequency. You may have to tune to 1.5 to 1.9 kHz above or below the actual listed frequency if copying sideband transmissions. The wave pattern in the cathode-ray tube window is used to properly adjust the signal.

A properly tuned signal should appear as an "X" pattern centered on the middle lines inscribed on the CRT window (fig. 1-27, view A). If the pattern is shifted above the bottom inscribed line (view B), the radio frequency needs to be lowered slightly. If the pattern is shifted below the top inscribed line (view C), the radio frequency needs to be raised slightly.

When the "X" pattern is centered, but the top and bottom pattern lines do not touch the top and bottom lines inscribed on the CRT (view D), the CV-483 "level" control must be increased. If the "X" pattern extends both above and below the top and bottom inscribed lines (view E), the "level" must be decreased.

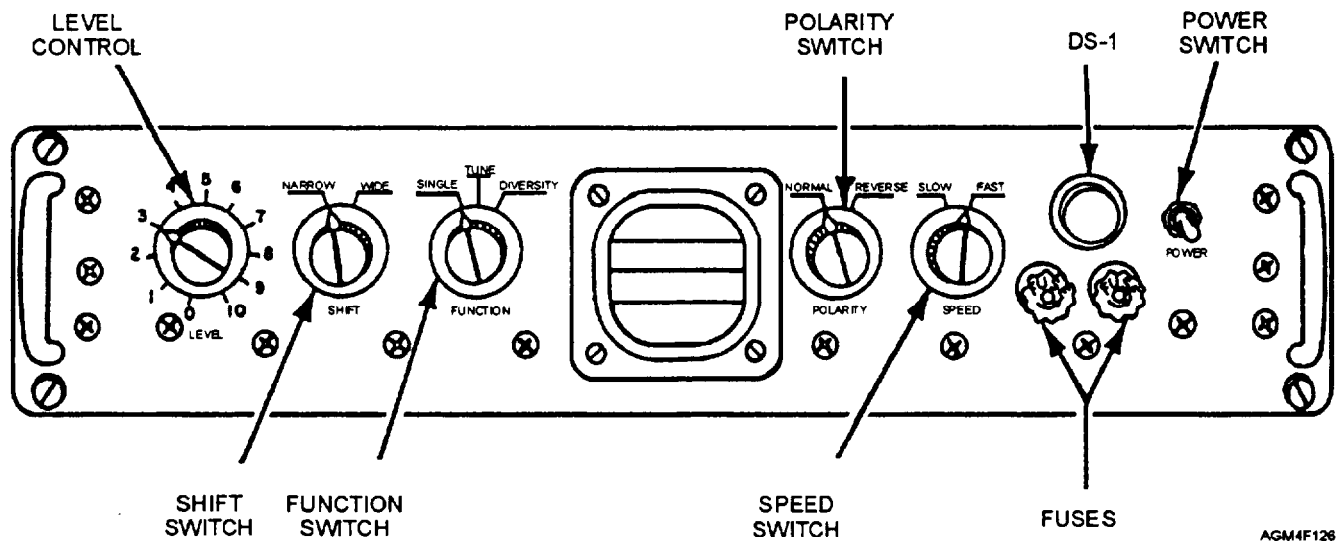
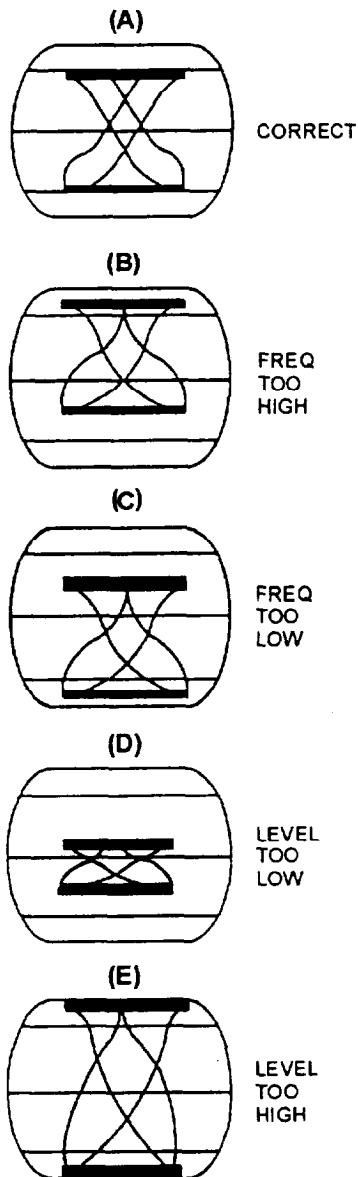

Figure 1-26.—Frequency Shift Converter CV-483/URA-17 front panel controls.

Table 1-6.—CV-483 Speed Setting Compared to RATT Baud Rate and Printer Word-Per-Minute Settings

SLOW	.45.5 BAUD	60 WPM
	.55 BAUD	75 WPM
FAST	75 BAUD	100 WPM



CV-483 CRT SIGNAL PATTERNS. VIEW (A) SHOWS A PROPERLY TUNED SIGNAL, VIEW (B) FREQUENCY IS TOO HIGH, VIEW (C) FREQUENCY IS TOO LOW, VIEW (D) THE CV-483 LEVEL IS TOO LOW, AND VIEW (E) THE CV-483 LEVEL IS TOO HIGH.

AGM4F127

Figure 1-27.—CV-483 CRT signal patterns. View (A) shows a properly tuned signal, view (B) frequency is too high, view (C) frequency is too low, view (D) the CV-483 level is too low, and view (E) the CV-483 level is too high.

4. Using the transfer switchboard, you may now connect the CV-483(s) to a teleprinter or TESS HF RATT input and switch the CV-483 function switch to the "single" setting. If the printer appears to be printing garbled letters and numbers, switch the "polarity" switch to the "reverse" position. If still printing garble, adjust the "speed" switch to "slow" and adjust the printer Words Per Minute (WPM) or Baud rate setting. *Baud* is the rate of modulation of a transmitted signal. The words-per-minute figure is an approximation based on the relationship that one word is six-unit characters of information. Baud rate times 1.35 is the approximate WPM rate. The CV-483 speed is related to transmission baud rates and WPM rates, as shown in table 1-6.

SHIPBOARD TELEPRINTERS

Observers in shipboard meteorological offices equipped with the TESS (3) or later versions of TESS may direct HP RATT signals into the TESS system for automatic sorting, storage, selected recall and display, or printing of alphanumeric information. IMOSS can also be used to copy RATT data. On ships not equipped with TESS or IMOSS, the incoming information must be directed to a printer. Currently, there are two basic types of shipboard teleprinters in use: the Teletype Corporation Model 28 (several different versions) and the Navy Standard Teleprinter (NST), the AN/UGC-143A(V).

Model 28 Teleprinter

The Teletype Corporation Model 28 teleprinter is a family of reliable low-speed teleprinters. Some versions are not equipped with a keyboard, and are known as *receive-only* (RO) teleprinters. Other versions have a keyboard and are known as *Keyboard Send-Receive* (KSR) teleprinters. In one version or another, Model 28 printers may still be found in shipboard meteorological offices. Some of the basic versions of the Model 28 are the TT-48/UG floor-mounted KSR teleprinter (fig. 1-28), the TT-69/UG tabletop KSR teleprinter (fig. 1-29), the AN/UGC-20 compact KSR teleprinter (fig. 1-30), and the AN/UGC-25 compact RO teleprinter (fig. 1-31).

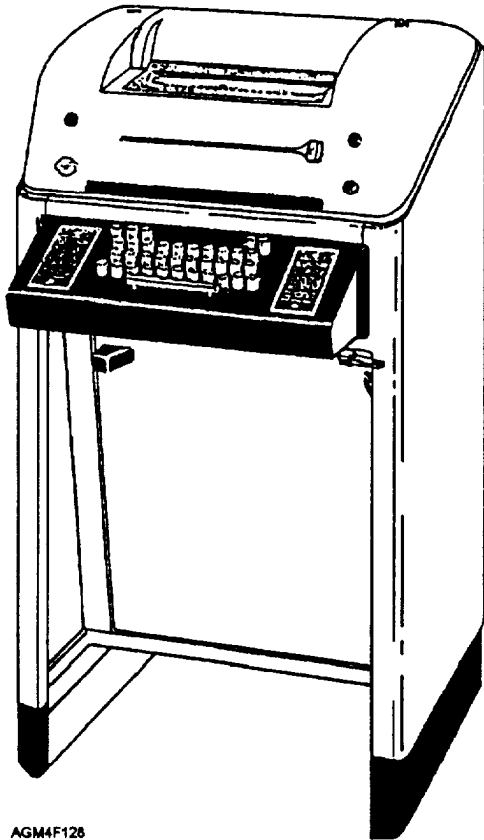

AGM4F128

Figure 1-28.—TT-48/UG Model 28 floor-mounted KSR teleprinter.

All teletype Model 28 printers use rolls of paper, which are inserted into the printer through the top. The paper may be single copy (single ply) or have three layers of paper and two layers of carbon (5-ply). Various colors of paper are also available. Usually, only single-ply yellow is used in meteorological

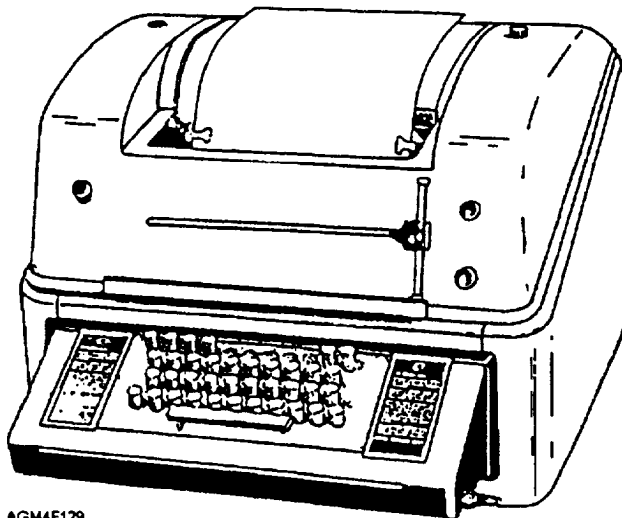

AGM4F129

Figure 1-29.—TT-69/UG Model 28 tabletop KSR teleprinter.

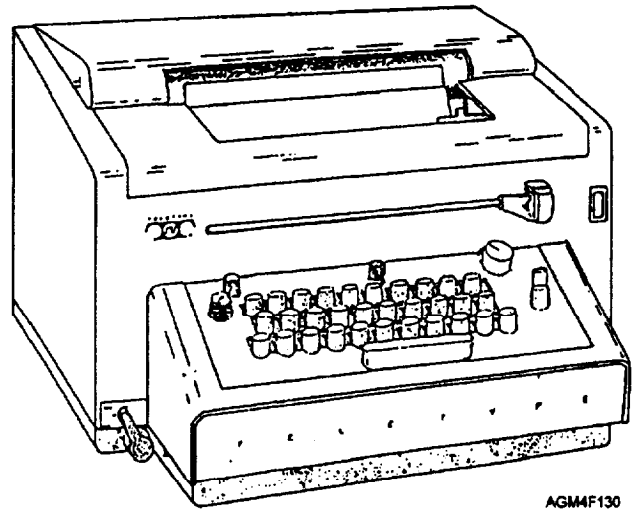

AGM4F130

Figure 1-30.—AN/UGC-20 Model 28 compact KSR teleprinter.

offices. Paper loading instructions are found inside the printer when the lid is opened.

These teleprinters use inked cloth ribbons, supplied on a single metal spool. Ribbon routing instructions are also listed inside the case. When installing a new ribbon, you must save one of the two used ribbon spools to attach to the new ribbon. Never reink and reuse old ribbons. Always replace them when the printing is very light or the ribbon shows signs of fraying or tearing, especially around the small metal eyelets near each end of the ribbon. These eyelets activate the ribbon-direction-reverse lever inside the teleprinter. If an eyelet tears loose from the ribbon, the reverse lever is not activated, and the ribbon advance gears or the ribbon mounting assembly may be damaged when the ribbon pulls taut.

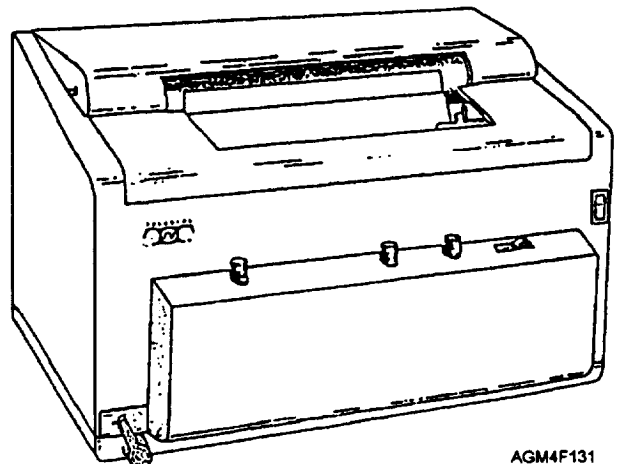

AGM4F131

Figure 1-31.—AN/UGC-25 Model 28 compact RO teleprinter.

Printing speed on the TT-48 and TT-69 teleprinters is adjustable by changing gears, but is usually set at 100 WPM. One of your shipboard Radiomen trained in teletype repair and maintenance will change the gears if necessary. On the UGC-20 and UGC-25 teleprinters, a switch lever on the left lower front edge of the printer is used to change printing speeds between 60 WPM, 75 WPM, or 100 WPM. Turn the power off before switching speeds.

Navy Standard Teleprinter

The AN/UGC-143A(V) Navy Standard Teleprinters (NSTs) have replaced most of the Model 28 teleprinters. The NST is designed for shipboard (both surface and subsurface) and shore station applications.

The NST is a high-speed electronic teleprinter that automatically accepts and processes transmissions from 45.5 baud up to 9600 baud. It prints 120 characters per second (1200 WPM). It is composed of several modules selectively connected to form the various configurations (configurations are discussed shortly). The NST may be used either as a tabletop unit or slide-mounted in standard equipment racks.

There are four versions of the AN/UGC-143A Teleprinter: the AN/UGC-143A(V)1 receive only-1 (RO1) teleprinter (fig. 1-32), AN/UGC-143A(V)2 receive only-2 (RO2) teleprinter (looks the same as an RO1), the AN/UGC-143A(V)3 keyboard send-receive (KSR) teleprinter (fig. 1-33), and the AN/UGC-143A(V)4 automatic send-receive (ASR) teleprinter (fig. 1-34). The various NST configurations consist of

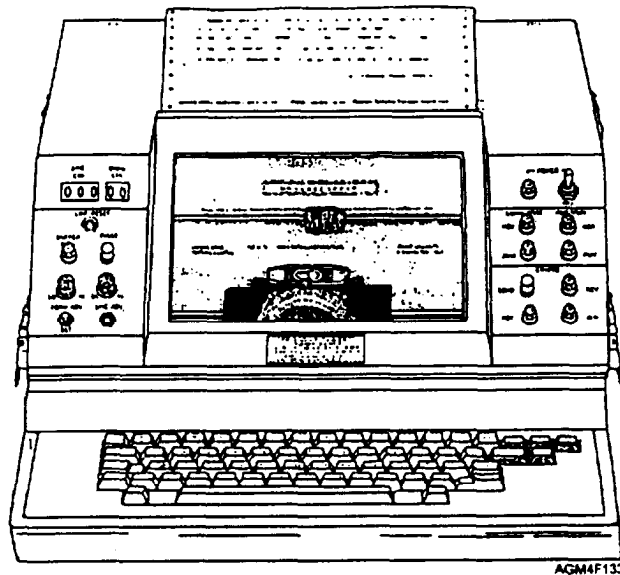

Figure 1-33.—AN/UGC-143A(V)3 keyboard send-receive (KSR) teleprinter.

combinations of one or several modules, such as the electronic module, printer module, keyboard module, keyboard/display module, or the bulk storage module. All four configurations contain basic electronics and printer modules. Only the RO2 and the ASR teleprinters contain a bulk storage module. Of the two keyboard configurations, the KSR has a standard keyboard, while the ASR has a Liquid Crystal Diode (LCD) single line display window.

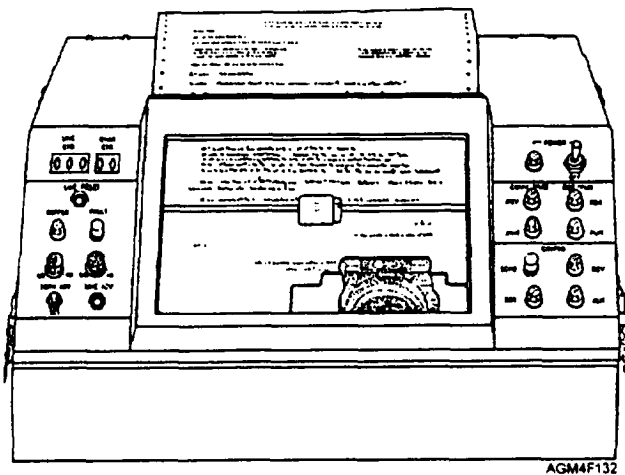

Figure 1-32.—AN/UGC-143A(V)1 receive only-1 (RO1) teleprinter, or the AN/UGC-143A(V)2 receive only-2 (RO2) teleprinter.

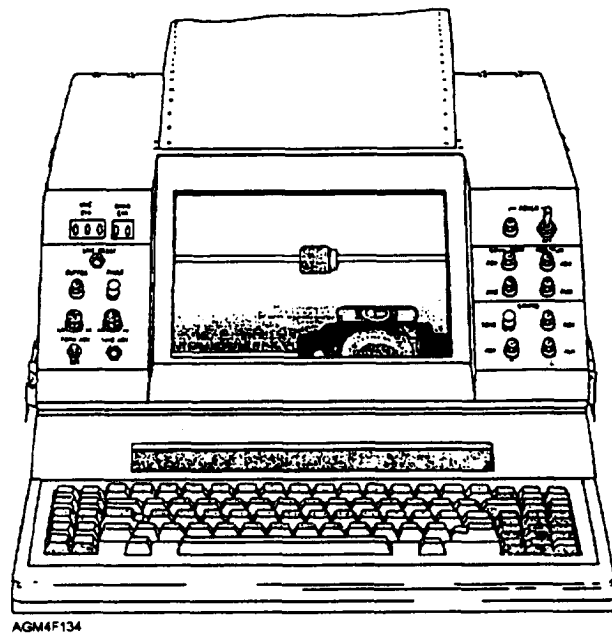

Figure 1-34.—AN/UGC-143A(V)4 automatic send-receive (ASR) teleprinter.

The electronic module controls the functional operations of the NST and provides temporary storage of all transmitted and received information. It contains a message buffer memory, message segmentation logic, message routing logic, communication port, crypto port, and power supply. The buffer compensates for varying baud rates and holds incoming traffic until the entire message has been received, and then sends it to the printer.

The printer module contains the printer mechanism, printer electronics, printer buffer, status indicator, system setup switches, and power supply. All received or transmitted information may be automatically printed. The operator can interrupt the printing mode without losing incoming message traffic to print directory information or internal systems test results. A dot-matrix print mechanism is capable of printing line lengths up to 80 characters at a speed of 120 characters per second (1200 WPM). (Until all Model 28 teleprinters have been replaced ashore and afloat, only 69 characters are allowed in a single message line.) Operator-selected, single- or double-line spacing modes are available. The printer uses either friction-feed nonperforated or tractor-feed perforated fan-fold paper. It is capable of accommodating single-ply paper or five-ply paper.

The keyboard module contains the basic complement of keys needed to send characters, release tape reader input, and perform tape editing. Another variation of the keyboard module includes a one-line (80-character) LCD display and special function keys that help the operator in message preparation and correction (fig. 1-35). The gray shaded keys are command or edit functions. Many of the remaining keys contain message functions, accessed by holding down the "shift" key as the function is depressed. Notice that the keyboard contains carriage return (CR), line feed, letters (LTRS), and figures (FIGS) keys, similar to the older Model 28 keyboards.

The bulk storage module contains the tape drive, drive electronics, message file logic, bulk storage buffer, function control switches, and power supply. It automatically stores all received and transmitted messages on a removable data cartridge. This module maintains an archive directory listing (table of contents) of all messages stored. The operator can have the table of contents printed or displayed on the keyboard module screen. The table of contents lists the messages in date-time group order and includes the originator, NAVCOMPARS processing sequence number (PSN), and an access number by which the operator can recall the message from storage. A data cartridge tape can store up to 1,344 messages of 2,000 characters each.



CONT CHAR	BULK	BS	!	·	#	\$	%	&	'	()	∅	=	E	{	G	}	TAB	KYBD ONLINE	TAPE EDIT	TAPE RECALL
CMP	CAN	REPEAT	D CQ 1	E TW B	E NE Q	D CR 2	D CT 4	E MY	N AU K	H TI	S IO	D LP E	N U L	F I S	U S	DELETE	BACK SPACE	NEXT TAB			
EDIT	RPT	LOCK	S OA H	D CS 3	E OD T	A CF K	B EG L	B H D	L J F	V K T	F L F	+	*	R S	CR	INSERT	↑	CHAR DEL			
	RTV	CTL	SHIFT	S UZ B	C AX N	E TC X	S YV N	S TB X	S ON	C RM	<	>	?	SHIFT	LINE FEED	←	END HOME	→			
	RLS		FIGS											LTRS		PRINT MEG	↓	LINE DEL			

AGM4F135

Figure 1-35.—AN/UGC-143A(V)4 ASR keyboard.

Operator maintenance on the equipment is limited to changing paper and printer ribbons. Instructions are provided on the inside of the printer case. Radiomen and Electronics Technicians perform all other maintenance.

Detailed operator instructions are contained in *Operator and Maintenance Instructions Teleprinter Set an/UGC-143A(Y)*. Specific instructions on the use of special message function keys and composing messages for teletype (or radioteletype) transmission are contained in *Communications Instructions, Teletypewriter (Teleprinter) Procedures, ACP-126*.

REVIEW QUESTIONS

- Q53. *When patching antenna jacks on the AN/SRA-12, which patch must be connected first?*
- Q54. *What are the two basic types of shipboard radio receivers?*

Q55. *How should a properly tuned signal appear on the CRT window of the CV-483/URA-17 converter?*

Q56. *What are the two basic types of shipboard teleprinters in use?*

SUMMARY

In this chapter, we have discussed many of the high-speed landline, satellite, and HP radio communications systems currently in use. We have also discussed much of the specialized equipment used as terminals on these communications systems. The specific communications systems and equipment available for use varies greatly from shore stations to ships. Although the systems currently in use are dramatically different and far more technologically advanced than the systems used only 10 years ago, we will see many more changes occurring as newer technology is introduced through early next century.

ANSWERS TO REVIEW QUESTIONS

- A1. *OPNAVINST 5510.1, Department of the Navy Information and Personnel Security Program Regulation.*
- A2. *For Official Use Only.*
- A3. *Not Releasable to Foreign Nationals.*
- A4. *A record slip or log entry must be made. In addition, official authorization maybe required.*
- A5. *The STU-III is a secure telephone system that provides protection of vital and sensitive information.*
- A6. *Internet links allow a user to download another document into their computer simply by clicking on an on-screen "link" from the current document.*
- A7. *Servers direct Internet traffic to its proper destination.*
- A8. *The abbreviation ".MIL" will appear as an extension at the end of the URL.*
- A9. *SIPRNET*
- A10. *METOC-related military websites usually contain information on command history, mission, as well as provide access to various environmental products.*
- A11. *The individual's name and host identifier.*
- A12. *The AWN is a system that collects and disseminates environmental data and other aviation-related information via satellite and landline circuits.*
- A13. *FNMOD Tinker, Oklahoma.*
- A14. *Automatic Response Query (ARQ).*
- A15. *The TT indicator of a MANOP header is used to identify message content. The AA indicator is used to identify the region for which the data is valid.*
- A16. *NOTAMS report items of interest to aviators, such as temporary or permanent runway closures, radar, communications, guidance system outages, or changes in facilities available at an airfield.*
- A17. *DIFAX products are copied by using an 18-inch satellite dish antenna.*
- A18. *MIDDS acts as an environmental workstation, a briefing station, and a method of distributing METOC products.*
- A19. *The MIDDS Fusion Generator allows you to overlay various products using different backgrounds and color schemes. Alphanumeric products can also be fused with other geo-referenced products.*

- A20. *The Dial RX receiver is used to acquire radar images from WSR-88D radar sites via a commercial dial-up service or the Internet. It can also be used to receive GOES satellite data, alphanumeric products, and DIFAX products.*
- A21. *The SAND function is used to display Satellite, NEXRAD (WSR-88D), and DIFAX images. SAND gives the user the ability to manipulate and enhance these products.*
- A22. *The FOS Module is an applications module used to display and manipulate alphanumeric data.*
- A23. *Briefing Support.*
- A24. *The ASOS Data Manager.*
- A25. *Gateguard.*
- A26. *Message Text Format (MTF) Editor.*
- A27. *Telecommunications Users Manual, NTP 3.*
- A28. *NAVMETOCCOMINST 3140.1.*
- A29. *The electronic Distributed Plain Language Address Verification System (DPVS).*
- A30. *The "NARR/" set identifier is used in a GENADMIN message when two or more references are listed in the message.*
- A31. *Less than 10 years from the date of the message.*
- A32. *Mission accomplishment and safety of life.*
- A33. *PMSV radio is used to relay meteorological information between aircraft and airfield weather offices.*
- A34. *I have received your signal, understand it, and will comply.*
- A35. *Wind TWO-FIVE-ZERO degrees, ONE-SEVEN knots.*
- A36. *Never relay the ship's name or position.*
- A37. *TESS is a modular, interactive, computer-based system which collects, processes, analyzes, displays, and disseminates METOC data and products. It is primarily installed aboard ships.*
- A38. *Internet access.*
- A39. *The TESS-NC Unix-based workstation is used to access the Global Command and Communications System-Maritime (GCCS-M) and tactical decision aids.*
- A40. *Five.*

- A41. *Mobile Environmental Teams (MET) and Meteorological Mobile Facility (METMF) members.*
- A42. *The main module.*
- A43. *The purpose of the communications module is to receive alphanumeric weather data and facsimile broadcast data via HF receiver, or satellite broadcast via shipboard communication facilities.*
- A44. *APT (polar-orbiting) and WEFAX (geostationary) imagery.*
- A45. *AUTODIN and the Fleet Environmental Broadcast are relayed to ships via SHF satellite as part of the Fleet Multi-channel Broadcast (FMCB).*
- A46. *NEMEOC Rota, Spain.*
- A47. *Selected AWN data, classified ship observations, and MET-Assist messages.*
- A48. *U.S. Air Force.*
- A49. *HF broadcasts from NAVMETOC regional centers are primarily used as a backup source for meteorological data aboard ship when routine fleet communications are not available.*
- A50. *Worldwide Marine Radiofacsimile Broadcast Schedules.*
- A51. *Lower frequencies.*
- A52. *TR4 minifax.*
- A53. *Insert the patch cord into the receiver first.*
- A54. *R-1051/URR and the R-2368/URR.*
- A55. *An "X" pattern.*
- A56. *The Teletype Corporation Model 28 and the Naval Standard Teleprinter (NST).*

CHAPTER 2

ENVIRONMENTAL SOFTWARE PROGRAMS

INTRODUCTION

In the Navy and Marine Corps fields of meteorology and oceanography, the use of desktop and laptop computers is common. In chapter one, we discussed several of the most widely used environmental computer systems. In this chapter, we will discuss many of the software programs and products associated with these systems.

Most environmental software programs are run on one of several computer systems, such as TESS, IMOSS, and MIDDS. These systems provide a wide range of environmental products. In this chapter, we will discuss the following programs:

- Oceanographic and Atmospheric Master Library (OAML)
- Geophysics Fleet Mission Program Library (GFMP)
- Tactical Environmental Support System (TESS) software
- Refractive effects prediction programs
- Electro-Optical Tactical Decision Aid (EOTDA)
- Naval Oceanography Data Distribution System (NODDS)
- Joint METOC Viewer (JMV)
- Optimum Path Aircraft Routing System (OPARS)
- Data Request Product (DRP)

Our intent is to provide you with a basic overview of the purpose of these programs and their output products. You will study more about the applications of these products in later training modules.

OCEANOGRAPHIC AND ATMOSPHERIC MASTER LIBRARY (OAML)

LEARNING OBJECTIVES: Describe the purpose of the Oceanographic and Atmospheric Master Library (OAML). Identify the agency responsible for maintaining OAML. Identify the publication that describes OAML.

The U.S. Navy has produced several oceanographic and atmospheric models and data bases over the last few decades. With similar environmental programs operating on different computer systems, small changes in program output can be realized by various warfare communities using the same products. In 1984, the Oceanographic and Atmospheric Master Library (OAML) was developed to provide consistency and standardization for all oceanographic and meteorological programs used by the Navy. *It is now the Navy standard library for meteorological and oceanographic data bases, models, and algorithms.* OAML thus eliminates large-scale differences in output from the various environmental computer systems that are used throughout the fleet.

The responsibility for maintaining the models and data bases in OAML rests with the Naval Oceanographic Office (NAVO) located at the Stennis Space Center, Mississippi. General descriptions of the various oceanographic and atmospheric models and data bases are provided in the *Oceanographic and Atmospheric Master Library (OAML) Summary* published by NAVO. The OAML summary discusses the applications and limitations of the OAML models and data bases. It also provides data base coverage maps as well as ordering instructions for OAML programs.

While OAML discusses many of the processing models and output products contained in the Geophysical Fleet Mission Program Library (GFMP),

it is not intended to discuss all of the various GF MPL programs available, only those commonly used by several warfare communities. Table 2-1 lists the most widely used OAML models and table 2-2 lists the data bases contained in OAML.

The OAML data bases and models are used in TESS, IMOSS, MIDDs, and many other environmental prediction systems used throughout the fleet. You will learn much more about the use of OAML models and

data bases as you progress into a senior Aerographer's Mate.

REVIEW QUESTIONS

- Q1. *What is the purpose of OAML?*
- Q2. *What agency is responsible for maintaining OAML environmental data bases and models?*

Table 2-1.—OAML Models

OAML MODELS	
OCEAN MODELS	ELECTROMAGNETIC (EM) MODELS
Modular Ocean Data Assimilation System (MODAS) Naval Search and Rescue (NAVSAR)	Surface-Search Radar (SSR) Model Radar Sea Clutter (CLUTTER) Model Standard Electromagnetic Propagation (Standard EM Prop) Model Evaporation Duct Height (EDH) Model Radar Free-Space Detection Range (RFSDR) Model Radio Physical Optics (RPO) Model
ACOUSTIC MODELS	OTHER MODELS
Passive RAYMODE Model Active RAYMODE Model Parabolic Equation (PE) Model Passive ASTRAL Range-Dependent Prop Loss Model Active Sensor Performance Model (ASPM) Colossus II Model Computer-Aided Sonar Tactical Recommendations (CASTAR) Model Low-Frequency Bottom-Loss (LFBLTAB) Model Surface-Loss (SRFLOS) Model System-Loss (SYSLOS) Model	High-Frequency (HF) Maximum Usable Frequency (MUF) Model High-Frequency (HF) Lowest Usable Frequency (LUF) Model Forward-Looking Infrared (FLIR) Range Prediction System Model Chaff Trajectory (CHATRA) Function Model Chaff Corridor Density (CCD) Model Chaff Dispersion (CHADIS) and Density Model Solar/Lunar Almanac Program (SLAP) Model
METEOROLOGICAL MODELS	
Radiological Fallout (RADFO) Model Meteorological Ballistic (METBAL) Winds and Densities Model Multivariable Optimal Interpolation (MVOI) Model Radiosonde Initial Analysis (RIA) Model	

Table 2-2.—OAML Data Bases

OCEAN DATA BASES	METEOROLOGICAL DATA BASES
Geophysical Data Base Ocean Floor Depth Digital Bathymetric Data Base Variable Resolution (DBDB-V) Icecap Data Base Ocean Floor Depth Digital Bathymetric Data Base One-Half Minute Resolution (DBDB-0.5)	Surface Marine Gridded Climatology (SMGC) Data Base Upper Air Gridded Climatology (UAGC) Data Base Global Tropical Cyclone Tracks (GTCT) Data base Northern Hemisphere Extratropical Cyclone Tracks (NHECT) Data Base
ACOUSTIC DATA BASES	ELECTROMAGNETIC DATA BASES
High-Frequency Bottom-Loss (HFBL) Data Base Low-Frequency Bottom-Loss (LFBL) Data Base Generalized Digital Environmental Model (GDEM) Data Base Shipping Noise (SN) Data Base Wind And Residual Noise (WRN) Data Base Historical Temporal Shipping (HITS) Data Base GDEM Province Subset (GDEMPS) Data Base Volume Scattering Strength (VSS) Data Base Vertical Line Array DIFAR (VLAD) Noise Gain Data Base	Historical Electromagnetic Propagation Conditions (HEPC) Data Base

GEOPHYSICS FLEET MISSION PROGRAM LIBRARY (GMPL)

LEARNING OBJECTIVES: Recognize how the Geophysics Fleet Mission Program Library (GMPL) relates to the environmental analysis and prediction systems in use. Identify the different versions of GMPL and associated publications. Describe the functions of GMPL. Identify the major environmental software programs of GMPL.

The Geophysics Fleet Mission Program Library (GMPL) is a collection of atmospheric and oceanographic software applications similar to OAML. It provides meteorological, electromagnetic, oceanographic, hazard avoidance, and acoustic software for fleet air, surface, amphibious, and undersea warfare (USW) operations. Other than being a collection of software, GMPL is also a program sponsored and directed by the Commander, Naval Meteorology and Oceanography Command (CNMOC)

to collect, evaluate, and incorporate new software developments for any meteorological or oceanographic application. Basic guidance on the software evaluation program is contained in NAVMETOCCOMINST 5232.1, *Geophysics Fleet Mission Program Library (GMPL)*.

GMPL contains software designed for use on many different types of desktop computer systems, including TESS, IMOSS, and MIDDS. Currently, there are three major versions of GMPL. The GMPL NT is the latest version and is distributed on CD-ROM. It is designed to work with the Windows NT operating system by using a Windows-type graphical user interface. Information describing the use of GMPL NT is contained in the *Geophysics Fleet Mission Program Library New Technology (GMPLNT) User's Manual*, published by NAVO. A second version, known as GMPL PC, is designed to run on DOS-based PC systems. It is distributed in both floppy diskette and CD-ROM. A users manual is provided with the disks. The latest and final version of GMPL PC was released in January 1998. In addition to the NT and PC versions of GMPL, a Unix-based version has been integrated

into the Global Command and Communications System-Maritime (GCCS-M), which was discussed in chapter one. Information describing the status of all GF MPL environmental programs and software versions is contained in the *Geophysics Fleet Mission Program Library (GF MPL) Summary*, also published by NAVO. Both the NT and PC versions of GF MPL are released as either unclassified or classified CD-ROMs. The classified GF MPL CD-ROMs contain detailed electromagnetic and acoustic models and data bases.

GF MPL FUNCTIONS

GF MPL is a rapid-response, on-scene, environmental prediction system used to quickly determine the effects of the environment on fleet platforms, sensors, and weapon systems. Locally collected environmental information is used to prepare analyses of present atmospheric and electromagnetic (EM) propagation conditions. Locally collected oceanographic information is combined with archived data to prepare an analysis of existing oceanographic and acoustic conditions. Analyses and predictions are based upon on-scene data, historical data, platform characteristics, and weapon/sensor characteristics. GF MPL comprises four basic functions as described below.

Environmental Data Assimilation

GF MPL accepts locally acquired environmental data from various sources, catalogs and processes the data, and then writes the data to available files for use by the various programs. This data includes operator-entered surface, radiosonde, refractivity, bathythermograph, and nearshore bathymetry data. This function also incorporates quality control checks of environmental data input.

Environmental Analysis

GF MPL generates analyses of existing environmental conditions affecting air, surface, amphibious, and USW operations. These analyses are provided by atmospheric, meteorological, and oceanographic application programs. The analyzed data is presented in the form of graphic and tabular displays, which can also be hardcopied and used for performance predictions and briefings.

Sensor Detection Range/Coverage Prediction

GF MPL computes acoustic and electromagnetic (EM) sensor range predictions based on oceanographic

and meteorological environmental profiles. Output is used for detection/counter detection of threat/force platforms. Platform and sensor data base parameters can be modified as necessary (both acoustic and atmospheric). Output is provided in either spreadsheet, graphical, or tabular format.

Data File Maintenance

This function provides the capability to create, maintain, and/or delete data files. This function also ensures the integrity of the data files and provides adequate safeguards for any classified information in the files.

GF MPL PROGRAMS

There are numerous environmental software programs available from GF MPL, and each version comes loaded with a different suite of programs. The environmental programs provided with GF MPL NT can be divided into seven broad categories, which are summarized below:

- **Environment**—This option contains general programs, such as Historical Electromagnetic Propagation Conditions (HEPC) and Propagation Conditions Summary (PCS). It also contains an ocean Sound Speed Profile (SSP) program.
- **Meteorology**—This option contains programs that calculate pressure altitude and density altitude data, wind chill and heat stress values, and astronomical data (sunrise, lunar illumination, civil twilight, etc.).
- **Electromagnetics**—This option contains programs that predict radar performance and calculate radar ranges. Electromagnetic programs include surface-search radar range predictions and electronic countermeasure effectiveness displays. Electromagnetic path-loss curves and radar coverage diagrams can also be produced.
- **Oceanography**—This option contains programs such as the Tidal Prediction and Analysis (TIDES), Surf Forecasting (SURF), and Beach Survey Chart (BSC). The BSC program allows for the creation, display, and editing of a digital beach chart as surveyed by Special Forces personnel.
- **Acoustic**—The Acoustic option contains the Generic Acoustic Prediction (GAP) program and the Tactical Oceanographic/Acoustic Spreadsheet (TOAS) program. GAP is used to produce horizontal contours of ocean temperature, sound speed, and salinity. It also

provides acoustic raytrace diagrams and propagation loss curves. TOAS computes active and passive USW range predictions by using operator-input data and a sensor/platform data base.

- Hazard Avoidance-This option contains the Naval Search and Rescue (NAVSAR) program and the Tropical Cyclone program. NAVSAR provides information and planning assistance for search and rescue incidents at sea, such as search probability maps (fig. 2-1). The Tropical Cyclone program tracks tropical cyclone movements and conditions on an operator-specified map. Input data is provided by tropical cyclone messages.

- Utilities-The Utility option contains a map utility function that provides the user with a geographical map. These maps are available in different projections. The utilities option also provides a briefing support tool (only with GF MPL NT).

REVIEW QUESTIONS

Q3. What is the purpose of GF MPL?

- Q4. What publication provides a description of the various GF MPL software versions?
- Q5. The analyses and predictions of GF MPL are based upon what inputs?
- Q6. The electromagnetic programs in GF MPL are used to provide calculations for what type of system?
- Q7. What programs are contained in the Hazard Avoidance option of GF MPL NT?

TACTICAL ENVIRONMENTAL SUPPORT SYSTEM (TESS) SOFTWARE PROGRAMS

LEARNING OBJECTIVE: Identify the various software programs available in the Tactical Environmental Support System, Version 3.0 (TESS 3); TESS-Next Century (NC) Transition; and TESS-Next Century.

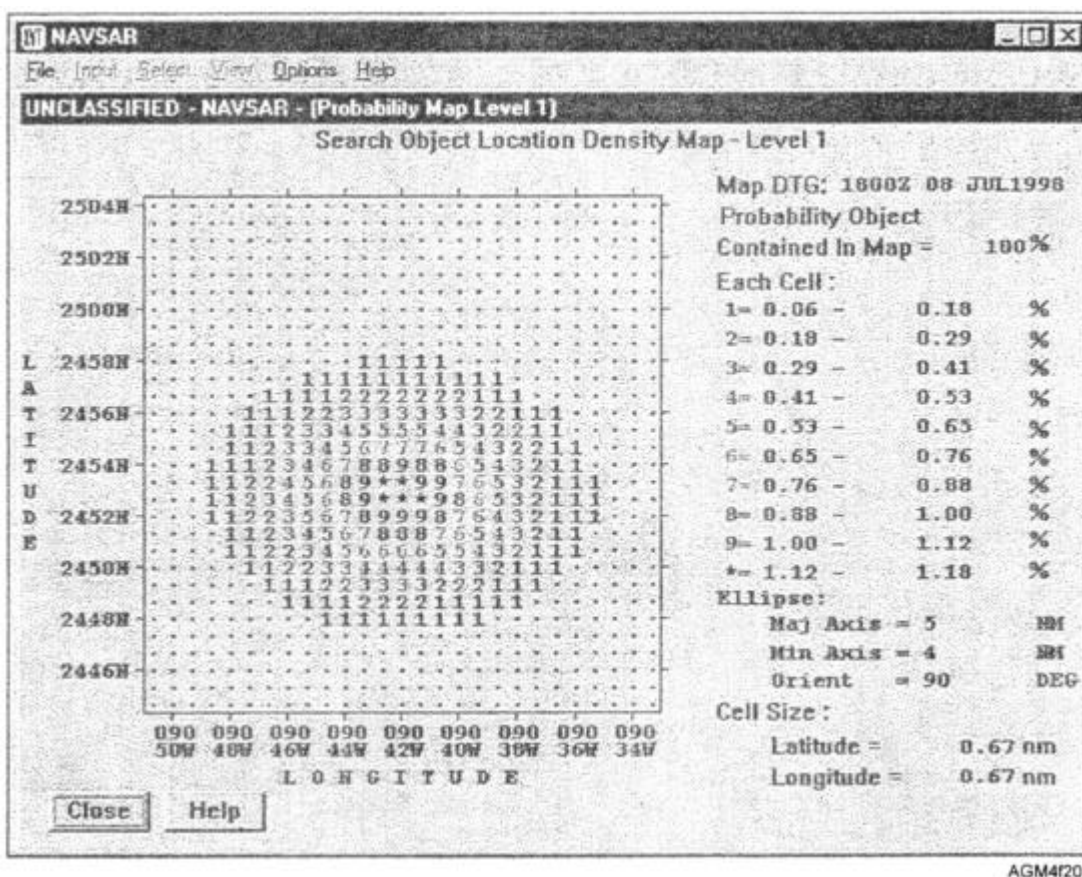

Figure 2-1.—Example of a NAVSAR search probability map from GF MPL NT.

As discussed in chapter one, the Tactical Environmental Support System (TESS) is designed to provide tailored meteorological, oceanographic, electromagnetic propagation, acoustic, and satellite products. The analyses and predictions from TESS are based mainly upon information obtained from various telecommunications channels, on-scene reports, and environmental software programs. Since its introduction, TESS has undergone major hardware changes and significant software improvements. We will discuss the environmental software programs available with the TESS (3), TESS-Next Century (NC) Transition, and TESS-Next Century (TESS-NC).

TESS (3)

The Tactical Environmental Support System, Version 3.0 (TESS 3), retained essentially the same

stand-alone workstation concept of earlier versions of TESS. However, TESS (3) was the first environmental workstation that provided connectivity between ships and shore-based METOC activities. An automatic shipboard observation system known as the Shipboard Meteorological and Oceanographic Observing System (SMOOS) was introduced in conjunction with this system. SMOOS is discussed in module 1 of this series.

TESS (3) was installed with a wide variety of environmental applications software, most of which come from the OAML and GF MPL models and data bases. Table 2-3 explains the application of several of these programs. Access to all programs is directed by screen menus, with user input via trackball or keyboard. Additional information is provided in the TESS (3) operator's manuals. All remaining TESS (3) systems will eventually be replaced by the TESS-Next Century system.

Table 2-3.—TESS (3) Environmental Programs

PROGRAM	APPLICATION	CONSIDERATIONS
Solar/Lunar Almanac Program (SLAP)	Produces monthly or daily summaries of ephemeral data for the sun and the moon. Data includes rise and set times, daylight and twilight periods, moon phase, etc.	Data only accurate for dates between 1985 to 2015. Potential for erroneous data above 60° latitude. Displayed times do not consider political and geographical limits.
Warning plot	Three subprograms plot tropical cyclones, high winds, and high seas.	No significant considerations.
Atmospheric Environmental File (AEF)	View atmospheric soundings prior to use in an environmental application. Holds a maximum of 10 soundings.	No significant considerations.
Radiosonde Initial Analysis (RLA)	Processes radiosonde data into arrays of parametric data. Determines significant altitude levels such as the freezing level, condensation level, and contrail formation levels, etc.	Requires the entry of latitude, longitude, and balloon release height.
D-values (DVAL)	Computes D-value profiles. A D-value compares the differences between the actual height above mean sea level (MSL) and the height of the same pressure surface in the U.S. standard atmosphere. The D-value is used to correct altitude settings for pressure-bomb detonations.	Maximum altitude of approximately 11,000 meters. Cautionary use for radiosonde data when the balloon is released at heights greater than 50 meters.

Table 2-3.—TESS (3) Environmental Programs—Continued

PROGRAM	APPLICATION	CONSIDERATIONS
Sound Focus (SOCUS)	Computes the focusing of atmospheric sound waves caused by an explosive blast. Normally used to determine liability for complaints or unintentional damage.	Computing sound focusing requires highly accurate environmental data. Prediction model was based on data collected from over-water and over-flatland explosions. May not be accurate for mountain terrains.
Ballistic Winds and Densities Corrections (BALWIN)	Computes ballistic wind and density correction factors for naval gunfire support.	Radiosonde data for the selected gunfire area must be used.
Radiological Fallout (RADFO)	Forecasts the pattern of accumulated radiation dose from a nuclear fallout. Used to determine ship and unit maneuvering to avoid potential nuclear radiation hazards.	Assumes meteorological conditions are constant throughout the fallout. Requires an accurate estimate of either the nuclear weapon yield or the height of the nuclear cloud. Does not assess thermal radiation, electromagnetic effects, or initial nuclear radiation. Used for only near-surface blasts.
Aircraft Icing Analyses (AIRICE)	Analyzes radiosonde data to determine the potential for ice accumulation on aircraft.	Computes the probability and the type of ice that may form. Icing may occur in between different radiosonde levels.
Ship Ice Accretion (SHIP ICE)	Estimates ship ice accretion based on time, wind speed, and air/sea temperatures.	More applicable for smaller ships. Does not consider the physical structure of the ship.
Tomahawk Environmental Calculation Aid (TECA)	Calculates weighted mean averages of wind speed, wind direction, and temperature for the overland flightpaths of Tomahawk strike missions.	Data is averaged for 1° square areas.
Atmospheric Refractivity Profile Generator (ARPGEN)	Creates or retrieves refractivity data sets for use by the various other EM programs.	Limited to 30 M-unit entries below 10 km in altitude. Refractivity data may be several hours old. Historical refractive data sets are retrieved for closest radiosonde station.
Electromagnetic (EM) Device Editor (EMDED)	Produces, edits, and maintains EM files (platforms, jammers, and ESM receivers) used in different EM programs.	The platform file can contain a maximum of 30 platforms of 15 EM systems each. Generic emitter files may be created. Provides maximum detection range for radars assuming the radar is operating.

Table 2-3.—TESS (3) Environmental Programs—Continued

PROGRAM	APPLICATION	CONSIDERATIONS
Electromagnetic Propagation Conditions Summary (PCS)	Graphically depicts refractive conditions of EM energy in the atmosphere. Describes in narrative the generalized refractive effects.	Not applicable for frequencies below 100 MHz or above 20 GHz.
Historical EM Propagation Conditions (HEPC)	Produces a historical summary of EM propagation conditions for a specific location and month.	No significant considerations.
Electromagnetic Coverage Diagram (COVER)	Provides the capability to determine how an EM system will perform in either detecting or communicating with a given target or receiver.	Does not account for horizontal changes in refractivity. Valid only for signals between 100 MHz and 20 GHz. Does not consider sea or land clutter. Accounts for ducting.
Electromagnetic Path Loss Versus Range (LOSS)	Produces an EM path loss for a user-specified EM system with respect to range. Program computes either an airborne- or surface-based path.	Does not account for horizontal changes in refractivity. Valid only for signals between 100 MHz and 20 GHz. Does not consider sea or land clutter. Accounts for ducting.
Surface-search Radar Range Tables	Determines SPS-10 and SPS-55 detection ranges for predefined U.S. and Russian-built naval platforms.	Does not account for horizontal changes in refractivity. Accounts for ducting. Requires accurate refractivity data.
Electronic Support Measures (ESM) Range Tables	Calculates and displays the maximum intercept ranges of U.S. and Russian-built surface emitters by a user-specified ESM receiver.	Maximum ranges limited to 541 nmi. Emitters are limited to the preset list. Use the Platform Vulnerability program for other emitters. Valid only for signals between 100 MHz and 20 GHz. Assumes the emitter is on and operating at peak power. Accounts for ducting and sea reflection.
Platform Vulnerability (PV)	Estimates the vulnerability of various emitters to a specified ESM system under varying environmental conditions.	Maximum range limited to 541 nmi. Valid only for signals between 100 MHz and 20 GHz. Assumes the emitter is on and operating at peak power. Accounts for ducting.
Battle Group Vulnerability (BGV)	Estimates the emitter vulnerability to a specified ESM system. Plots intercept ranges for surface-to-air, air-to-air, and air-to-surface geometries. The object is to minimize the BG vulnerability to counter-detection	Maximum range limited to 541 nmi. Valid only for signals between 100 MHz and 20 GHz. Assumes the emitter is on and operating at peak power. Accounts for ducting

Table 2-3.—TESS (3) Environmental Programs—Continued

PROGRAM	APPLICATION	CONSIDERATIONS
Electronic countermeasure (ECM) Effectiveness Display	Measures airborne jammer effectiveness against surface-based (victim) radars. Determines optimum locations and flight paths of attacking aircraft.	Does not account for horizontal changes in refractivity. Valid only for signals between 100 MHz and 20 GHz. Does not consider sea or land clutter. Accounts for ducting. The victim radar must be surface-based.
Chaff	Aids in the planning of chaff usage in tactical air-strike missions and shipboard defense. Displays chaff frequency response, optimum chaff corridors, and recommendations for chaff defense against cruise missiles.	Does not consider refractive effects.
Forward-Looking Infrared (FLIR) System Prediction	Determines the operational ranges of airborne FLIR devices against surface targets.	Assumes the environmental data is representative of the entire search area. Computed range is for detection, not categorization. Under high-visibility and/or dry-air conditions, predictions are often farther than the actual detection range.
Laser Range Prediction (LRP)	Displays range information for exposures to low-level laser radiation. Includes height vs. range and day vs. night calculations. Additionally, displays range vs. time of exposure for different levels of laser radiation exposure.	Computes average laser power for a 1-sec period. No power increase is computed for magnification effects (e.g., binoculars). Program works on a wavelength-specific basis. Not applied to air-to-air cases.
Ocean Environmental File (OEF)	Contains recently input and frequently used BT observations, associated sound speed profiles (SSPs), passive propagation loss (PL) curves, and environmental data.	No significant considerations.
Sound Speed Profile (SSP) Generator	Computes SSPs for specific ocean conditions.	Cautionary use of product with no BT data that extends below 200 m.
Ocean Data Analysis (ODA)	Provides automated on-scene analysis of ocean thermal structure and acoustic properties. Also displays historical information. Provides methods for displaying historical bottom depth, bottom loss, and water mass data.	May contain a maximum of 1,000 observations. Approximately 500 observations can be stored on a floppy disk. A specific area ranging from 0.1° to 20° square can be analyzed. Analysis can be performed on a maximum of 50 BT observations at a time.

Table 2-3.—TESS (3) Environmental Programs—Continued

PROGRAM	APPLICATION	CONSIDERATIONS
Raytrace	Graphically displays the interaction between the environment and the sound energy propagating through it. Traces and displays paths of individual sound rays.	Raytrace uses a single SSP thus the sound speeds generated by this program are controlled by depth but not range. Ray diagrams are sensitive to user's selection of launch angle, source depth, bathymetry, and sound speed.
Tidal Prediction (TIDES)	Forecasts tidal heights for any location for which observed tide data is available.	Tidal currents are not predicted. Impacts of storm surge and surf conditions are not addressed. Tidal height extremes predicted to the nearest 6 minutes.
Naval Search and Rescue (NAVSAR)	Provides search assistance by assessing the probability of the search object location. Recommends specific search plans.	Search plans include the type of object, density of the search area, and sweep paths for visual and electronic sensors.
Surf Forecasting (SURF)	Provides predictions of surf conditions as ocean waves move from deep water through the surf zone and onto shore. Modified Surf Index (MSI) is also calculated.	Tidal data may not be complete. Variable bottom features can invalidate earlier data.
Passive Acoustic Propagation Loss (PPL)	Calculates transmission loss as a function of range, frequency, source depth, and receiver depth. These calculations are used to predict USW sensor system performance.	Systems are preset for an omnidirectional sonobuoy. Minimum range and range increments are preset to 1,000 yards. Horizontal homogeneity of the watermass is assumed.
Generalized Range-dependent Acoustic Driver (GENRAD)	Aids the use of the Navy Standard range-dependent passive prop loss models. Provides a means to position on-scene and historical SSPs along a specific line of bearing for further acoustic calculations.	Many considerations; refer to <i>TESS 3.0 User's Guide</i> .
Sensor Performance Predictions (SPP)	Calculates sensor performance predictions using platform and sensor characteristics.	Noise characteristics of U.S. and Russian-built platforms are class averages. Can be used for counter-detection. Each threat platform can be characterized by a maximum of 20 narrowband and/or broadband signature frequencies. Many considerations; refer to <i>TESS 3.0 User's Guide</i> .

Table 2-3.—TESS (3) Environmental Programs—Continued

PROGRAM	APPLICATION	CONSIDERATIONS
Ambient Noise (AN)	Provides noise predictions. Corrects for local, seasonal, directional, and omnidirectional levels.	Designed for deep water. Unreliable predictions for water depths less than 300 m deep.
Tactical Oceanographic Acoustic Spreadsheet (TOAS)	Computes sensor prediction data using platform/sensor data bases, the propagation loss model, and associated data bases. Requires minimal user response.	Many considerations; refer to <i>TESS 3.0 User's Guide</i> .
Edit Orbital Element Set (EDORD)	Allows editing of satellite orbital data.	Few limitations for satellite orbital data.
Orbital Satellite Prediction (ORBSAT)	Provides satellite-pass summaries consisting of rise and set time, pass duration, ship position during the pass, and maximum elevation.	Rise and set time error ranges from 1 to 5 sec. Predictions limited by the number of satellites for a specific latitude area.
Geostationary Satellite (GSAT) Prediction	Computes antenna-aiming data based on operator-specified ship location and bearing, and the satellite longitude.	Assumes a stationary platform.

TESS-NEXT CENTURY (NC) TRANSITION

The TESS-Next Century (NC) Transition was released as an interim system to fill the void between TESS (3) and the full deployment of TESS-Next Century. As discussed in chapter 1, significant changes to TESS were introduced with this system, with Internet access being the most important advantage. In addition to Internet access, the TESS-NC Transition includes a wide variety of commercial and government software programs. Commercial software programs include the Windows NT operating system, Microsoft Office, and commercial web browsers. Government software includes the Joint METOC Viewer (JMV), the Electro-Optical Tactical Decision Aid (EOTDA), and SMOOS interface software. In addition, several of the environmental programs in MIDDs are installed with the TESS-NC Transition.

TESS-NEXT CENTURY

TESS-Next Century (TESS-NC) retains several of the same software packages as the TESS-NC Transition system. As of this writing, the total complement of software programs has not been fully developed. TESS-NC operates using the Windows NT Server and Workstation Operating System and maintains SMOOS

interface capability. Commercial word processing and graphics programs center around Microsoft Office programs. Commercial web browsers are also included with the system. Government software programs include the JMV program, the EOTDA program, and refractivity prediction programs, which are discussed shortly. Additional government software includes various GFMP programs, such as TIDES and SURF, and software programs from MIDDs, such as the SAND application (discussed in chapter 1).

As mentioned in chapter 1, TESS-NC also includes a data base server and workstation that operate using an HP-UX (UNIX) Operating System. This workstation is used to access tactical applications programs via the Global Command and Control System-Maritime (GCCS-M). In addition, the SPPED/ICAPS II Integrated Product (SIIP) is run from this workstation. SIIP is a series of several integrated environmental programs that access historical and tactical data bases. SIIP products include sound speed profiles (SSPs), acoustic raytraces, ocean data analysis products, passive acoustic propagation loss (PAPL) displays, sensor performance prediction (SPP) profiles, and ambient noise (AN) data.

REVIEW QUESTIONS

- Q8. *What is the purpose of the COVER program?*
- Q9. *What are the limitations of the SSP program?*
- Q10. *What is the major software advantage with the TESS-NC Transition as compared to the TESS (3)?*
- Q11. *Which government environmental software programs are provided with the TESS-NC?*
- Q12. *What is the purpose of the TESS-NC Unix-based workstation?*

REFRACTIVE EFFECTS PREDICTION PROGRAMS

LEARNING OBJECTIVES: Identify the purpose of refractive effects prediction programs. Identify the refractive effects displays available with the Integrated Refractive Effects Prediction System (IREPS) and the Advanced Refractive Environmental Prediction System (AREPS). Describe the major advantages of AREPS.

Refractive effects prediction programs are designed to provide Aerographer's Mates with the capability of assessing the refractive effects upon naval surveillance, communications, electronic warfare, and weapon-guidance systems. Either historical or real-time upper-air sounding data is used as input.

INTEGRATED REFRACTIVE EFFECTS PREDICTION SYSTEM (IREPS)

The first refractive assessment software program was the Integrated Refractive Effects Prediction System (IREPS) developed in the late 1970s. IREPS is designed for use over open ocean areas only. The program assumes the homogeneity of the atmosphere (single air mass) based on the input of a single upper-air sounding. Output options include various refractive effects products such as electromagnetic propagation conditions summaries (PCS), radar coverage display diagrams (COVER), path-loss versus range displays (LOSS), surface-search radar range tables (SSR), and Electronic Support Measures (ESM) radar intercept-range tables. The applications and limitations of these programs were covered with TESS (3) in the previous section. Although IREPS is resident software on TESS (3), it is no longer issued as a stand-alone program. In

addition, most of the products produced by IREPS have been incorporated into GF MPL.

ADVANCED REFRACTIVE ENVIRONMENTAL PREDICTION SYSTEM (AREPS)

The most current refractive effects assessment program is the Advanced Refractive Environmental Prediction System (AREPS). AREPS computes basically the same refractive tactical decision aids as IREPS. However, AREPS uses a more advanced prediction model that produces more accurate data. The most significant advantage of AREPS is that it can produce refractive effects predictions *over land* using terrain data obtained from either the National Imagery and Mapping Agency (NIMA) or the user's own sources. In addition, AREPS is able to evaluate range-dependent scenarios, and can also compute radar detection ranges for multiple bearings simultaneously. As of this writing, users must build their own electromagnetic files as there is no electromagnetic data base provided with the program. Figure 2-2 is an example of an AREPS radar coverage diagram. The *AREPS User's Manual*, SSC San Diego Technical Document 3028 provides a detailed description of the AREPS program.

AREPS is designed to run using Windows 95 or Windows NT and is normally obtained as part of the GF MPL NT package. You can also download the AREPS program and the AREPS manual from the SPAWARS website at: <http://sunspot.spawar.navy.mil>. CD-ROM versions of AREPS are available from SPAWARS on a request-only basis.

REVIEW QUESTIONS

- Q13. *What is the purpose of refractive effects prediction programs?*
- Q14. *What is the most significant advantage of AREPS over IREPS?*

ELECTRO-OPTICAL TACTICAL DECISION AID (EOTDA)

LEARNING OBJECTIVES: Define the term *Electra-Optics*. Identify the purpose of the Electro-Optical Decision Aid (EOTDA) program. Recognize the output options available from the EOTDA program.

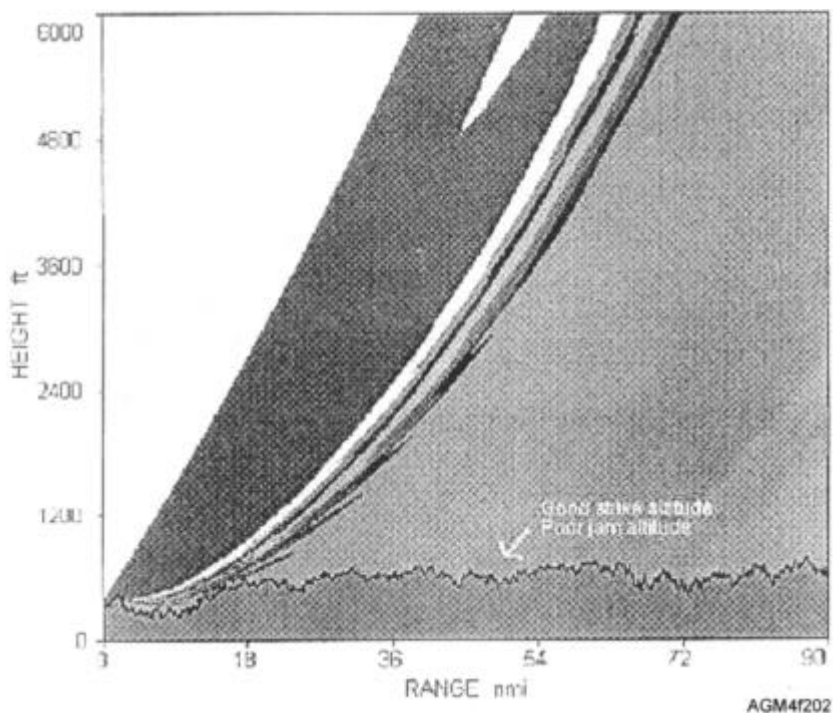

Figure 2-2.—Example of an AREPS radar coverage diagram.

As applied to military operations, the term *Electro-Optics*, or EO, refers to those weapons that require the propagation of electromagnetic energy through the atmosphere for their operation. Although EO systems can operate throughout the entire electromagnetic spectrum, most systems operate in the visible or infrared portions of the spectrum. EO systems are greatly affected by 'environmental conditions, such as precipitation, haze, and other aerosols. In addition, infrared systems are affected by differences between the temperature of the target and the temperature of the surrounding environment (background).

In the early 1980's, computer programs were developed to aid the Aerographer's Mate in predicting the affects of various environmental parameters on EO systems. The most recent model is known as the *Electra-Optical Tactical Decision Aid (EOTDA)*. EOTDA is a software program whose main function is to predict the performance of air-to-ground weapon systems and direct view optics based on the latest environmental and tactical information. EOTDA supports systems operating in three regions of the electromagnetic spectrum: infrared, visible, and laser. Predictions are based upon meteorological forecasts, target characteristics, the components of the EO system, and tactics. The performance of each system is

expressed primarily in terms of maximum detection or lock-on range. Prediction data is displayed in either alphanumeric or graphic format. Figure 2-3 is a sample infrared (IR) visualization display (tank with vegetation background).

EOTDA is a DOS-based program contained on floppy disks that can be loaded on virtually any PC. However, it is a large program that requires much hard disk space. Additional hard disk space is required if several generic targets must be created. The EOTDA program is outlined in the *Electra-Optical Tactical Decision Aid (EOTDA) User's Manual*, prepared by Phillips Laboratory in conjunction with the U.S. Air Force. As of this writing, a Windows NT version of EOTDA is being developed for use with TESS-NC.

Keep in mind that the EOTDA software itself is unclassified. When a user adds operational data that makes the output classified, such as times, locations, etc., the user must then take precautions to protect the information at the appropriate level. Appendix B of the Users Manual provides a detailed listing of sensor names, identifications, and classification information. It is classified SECRET and must be ordered separately. You will learn more about the tactical application of electro-optical products in later modules.

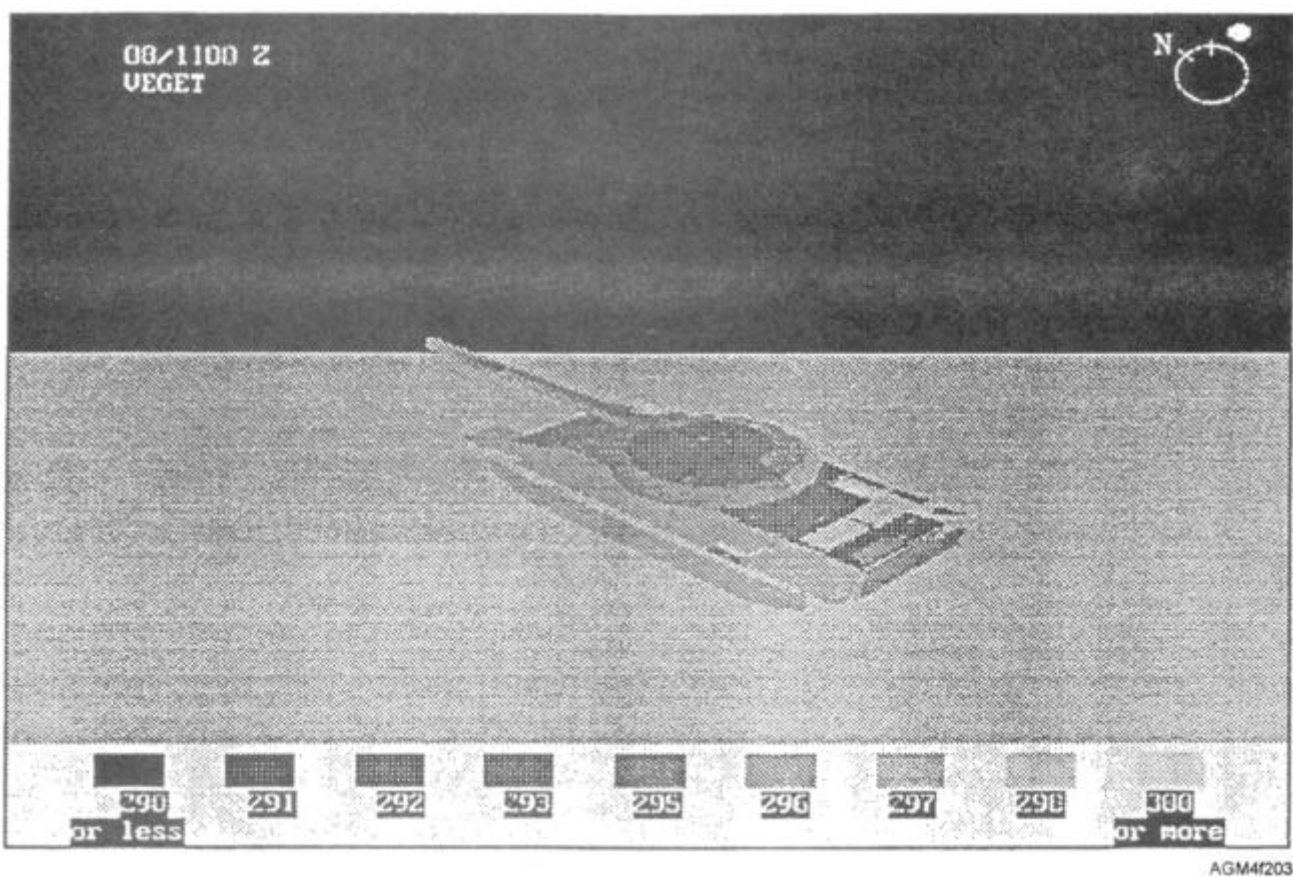

Figure 2-3.—EOTDA infrared (IR) visualization display (tank with vegetation background).

REVIEW QUESTIONS

- Q15. EOTDA supports systems that operate in what part of the electromagnetic spectrum?
- Q16. EOTDA predictions are based on what input?

NAVY OCEANOGRAPHIC DATA DISTRIBUTION SYSTEM (NODDS)

LEARNING OBJECTIVES: Describe how Navy Oceanographic Data Distribution System (NODDS) products are obtained. Identify the products that are available from NODDS. Identify the processing and display features of NODDS.

The Navy Oceanographic Data Distribution System (NODDS) is a DOS based software program which makes environmental products from the Fleet

Numerical Meteorology and Oceanography Center (FNMOC) available to DOD activities. NODDS products are normally obtained using standard telecommunications circuits (commercial/DSN/STU-III) but can also be obtained via NIPRNET, and e-mail. Data processing and display are accomplished using standard PC hardware. Users require ID and passwords to access the system.

NODDS was first developed in 1982 as a means to make FNMOC environmental products available to METOC facilities and detachments that had no direct access to this data. Through the years, the system has grown in use, and product support has expanded. The latest software version is NODDS 4.1. The program is normally installed on MIDDS, but can also be installed on any standard 486 (or better) CPU with a VGA color monitor, hard disk, and mouse. A minimum 9.6 kilobytes per second (KBPS) modem is required, but a 28.8 KBPS modem or greater is recommended.

NODDS PRODUCTS

There are numerous environmental products available from NODDS. Meteorological products include surface pressure, pressure heights (up to 200 hPa), cloud cover and precipitation data, high wind and high seas warnings, and tropical cyclone warnings. Oceanographic products include sea/swell height, period, and direction data, sea surface temperature data, mixed layer depth data, fronts and eddies data, and various acoustic path range products. Satellite imagery (DMSP only) can also be downloaded. Figure 2-4 is an example of a surface pressure analysis with a horizontal weather depiction (HWD) overlay.

NODDS PROCESSING AND DISPLAY FEATURES

NODDS allows users to select the geographical area of interest and desired products via mouse point and click options. Once the area and data selections are complete, automatic access to the FNMOC model data base is made via a dial-in connection. Since the geography information is resident in the user's PC, only gridded environmental data covering the area of interest is downloaded. This data is compressed, thus keeping tile size, access time, and communications costs to a minimum.

There are several processing, display, and annotation options as NODDS gives the user the flexibility to view data in the way most appropriate for the application. Display options allow for contouring,

shading, 3-dimensional plots, and synoptic station model plots. In addition, Skew-T diagrams, streamlines, oceanographic temperature profiles, and ocean temperature cross sections can also be plotted. HWD charts can be constructed by simply clicking on the applicable weather symbol icons that are provided with the program.

As mentioned, a significant advantage of NODDS is that it provides the capability to define an area of interest and display different types of data for that area. All standard meteorological fields available from FNMOC can be displayed along with a wide number of oceanographic and acoustic products. NODDS has the capability to overlay up to three different fields, or display individual sequence loops. Fields can also be zoomed for more detail, and sent to a graphics capable printer. The *Navy Oceanographic Data Distribution System (NODDS) Manual*, FLENUMETOCEN Publication 3147, can be downloaded from the FNMOC website. The *Navy Oceanographic Data Distribution System Products Manual* describes the applications and limitations of various products available from NODDS. A list of available NODDS products is also contained in the *FNMOC Products Manual*, FLENUMETOCEN P-3140.

In rare instances, NODDS may be obtained via AUTODIN message. The ship or activity requests the area of coverage and the desired products. FNMOC then incorporates the data into a composite file and transmits the information via radio message (or e-mail). This data can then be saved to diskette and uploaded on a PC.

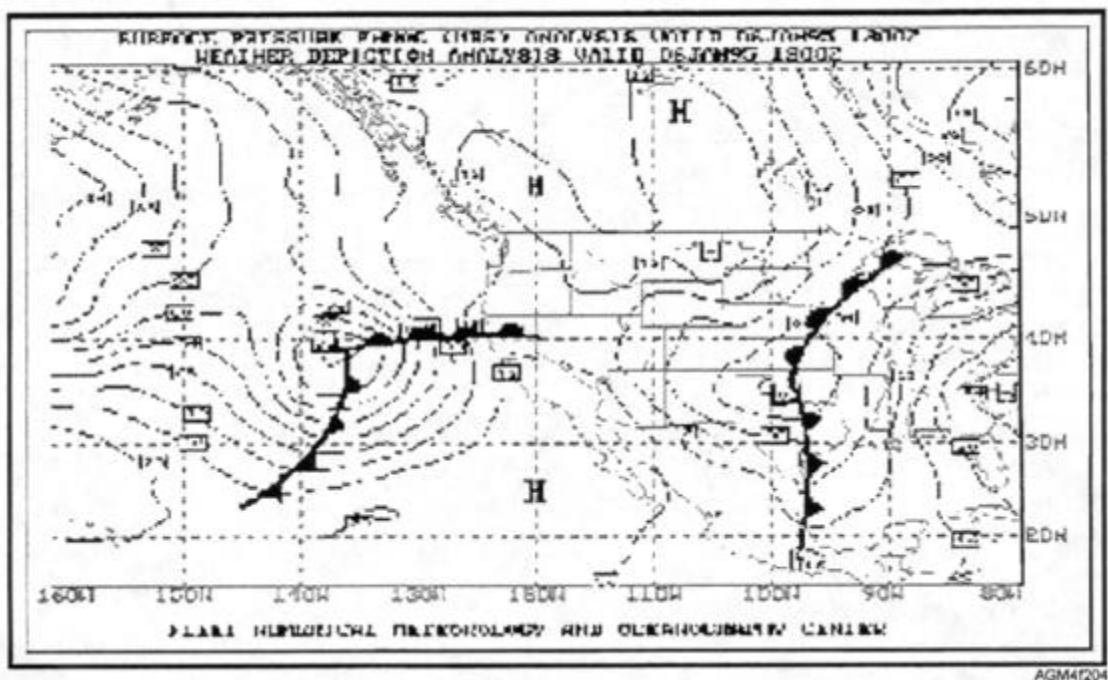

Figure 2-4.—Example of NODDS surface pressure analysis with HWD overlay.

REVIEW QUESTIONS

- Q17. *How are NODDS products obtained?*
- Q18. *What types of products can be obtained from NODDS?*
- Q19. *What is a significant processing advantage of NODDS?*

JOINT METOC VIEWER (JMV)

LEARNING OBJECTIVES: Identify how products are obtained from the Joint METOC Viewer (JMV). Identify the manual that explains the use of JMV. Describe the major features of the Joint METOC Viewer (JMV). Identify the types of products available from JMV.

The Joint METOC Viewer (JMV) is an easy-to-use tool for displaying and annotating meteorological and oceanographic data. JMV is quite similar to NODDS, although JMV products are obtained exclusively via the Internet. JMV consists of software that utilizes web technology (INTERNET/NIPRNET/SIPRNET) as a means to make FNMOC environmental products available to regional METOC centers. These products can then be obtained by facilities, detachments, and other DOD users who have web access. The computer hardware and operating system combination necessary to run JMV is a PC with Windows 3.1, Windows 95, or Windows NT. In any case, the user must have a working knowledge of Windows. Products for display in JMV are accessed only from Naval METOC regional centers or directly from FNMOC. Once downloaded, products can be viewed, customized, exported, or archived. There are far more display options and graphics tools available with JMV than with NODDS.

Detailed information concerning JMV is provided in the *Joint METOC Viewer User Manual*, FLENUMETOCEN P-352, which can be downloaded from the FNMOC website. A list of products from JMV is also contained in the *FNMOC Products Manual*. To request an account for JMV and the web page, users must be members of the Department of Defense or authorized DOD contractors. All requests for accounts should be sent to the FNMOC web master at: <http://www.webmaster@fnoc.navy.mil> (accessible through the FNMOC web page). Routine requests for new areas or changes to the data contained in an area can also be made by contacting the FNMOC web master.

JMV FEATURES

JMV is unique in its approach to environmental data communications. A JMV thumbnail (defined regional area) and associated product list is defined on the host computer at the regional center. The data is then stored on the host computer and any authorized user can download it to their computer using the JMV software package. Once the raw data is received by the computer, the required contouring, streamlining, shading, etc., is performed automatically until all products are in a ready-to-display format. The user has the ability to select contour intervals, change colors (both screen and printer), and can also select unit preferences (Metric/English). JMV has the ability to overlay up to three different fields at once and display individual sequence loops. Figure 2-5 is an example of a surface pressure analysis from JMV.

JMV PRODUCTS

JMV currently provides only the regional centers (host computers) with the capability to define areas of interest and select the different gridded products for the defined areas. Other users must notify the appropriate regional center of their area and product requirements via telephone or email. The obvious limitation to this process is that the geographical areas and associated product lists are predefined by the regional centers and by FNMOC. This problem will eventually be eliminated as more powerful servers are introduced. Software upgrades to JMV will also allow for slide show presentations, tropical cyclone warning plots, a "ship route" display feature, and other graphics improvements. A list of JMV products is detailed in section 2.3.5. of the JMV Users Guide. Watch personnel at each of the regional centers provide 24-hour support for JMV.

There are several other products that are currently available from FNMOC via the NIPRNET. These include various satellite products, meteorological and oceanographic forecast products, and forecast model reports, summaries, and tendency reviews. Check the FNMOC website for details.

REVIEW QUESTIONS

- Q20. *How are JMV products obtained?*
- Q21. *What is the easiest method to obtain the "Joint METOC Viewer User's Manual"?*
- Q22. *JMV defined-areas are established by what activity(s)?*

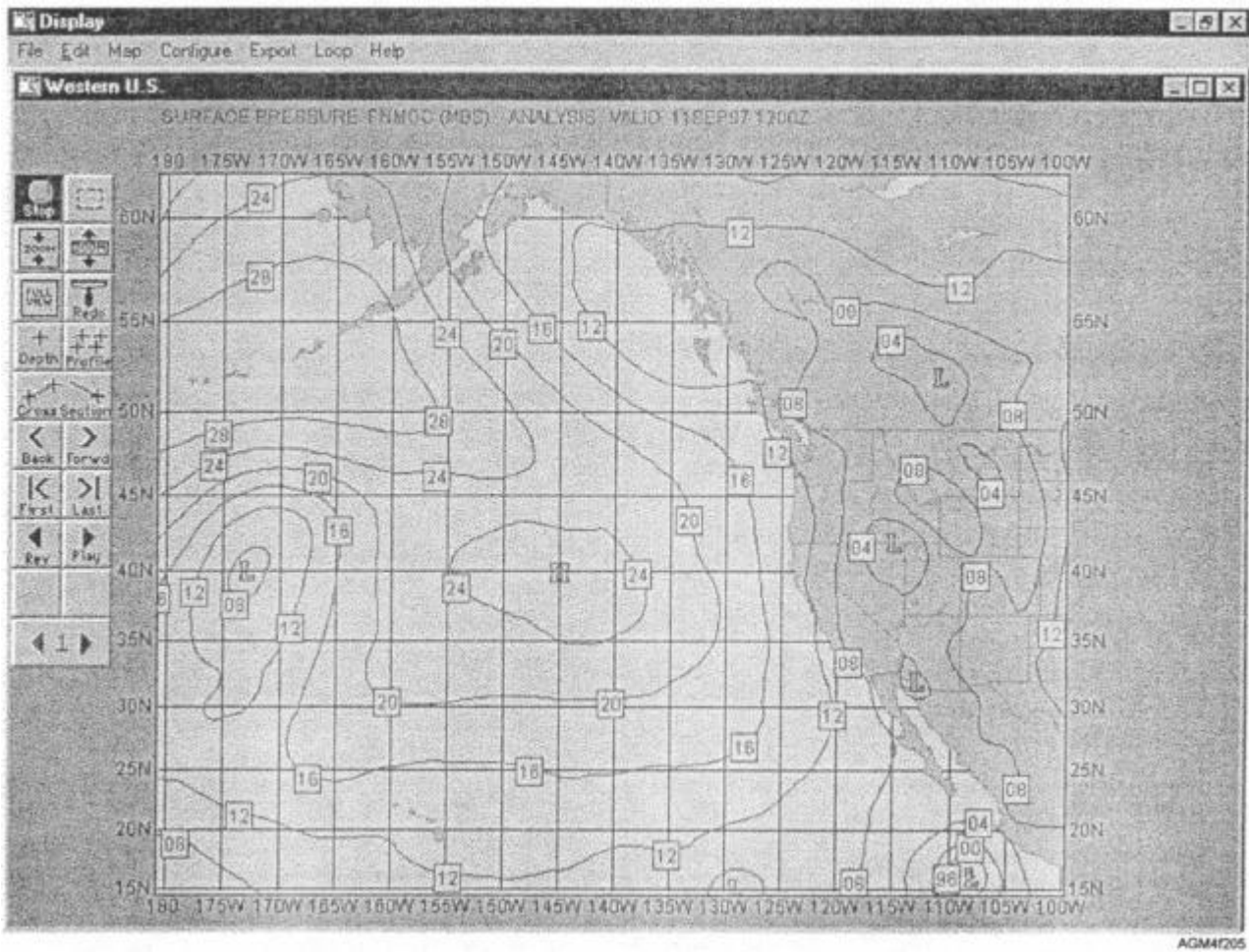

Figure 2-5.—Example of a surface pressure analysis from JMV.

OPTIMUM PATH AIRCRAFT ROUTING SYSTEM (OPARS)

LEARNING OBJECTIVES: Identify the purpose of the Optimum Path Aircraft Routing System (OPARS). Recognize the OPARS subsystems. Describe the information required to process OPARS flight plans. Identify the publication that outlines OPARS processing procedures.

The Optimum Path Aircraft Routing System (OPARS) is a computer program that selects the best (optimum) route and altitude for an aircraft to reach a destination. The primary purpose of OPARS is to provide a flight planning service to the Naval Aviation

community that minimizes time enroute and fuel consumption. The system combines the latest environmental data with the most fuel efficient flight profile for a specific aircraft, and then produces a customized *flight plan* for the pilot. An OPARS flight plan acts as a preflight planning aid that serves as a supplement to the DD Form 175-1 Military Flight Weather Brief. OPARS users connect with the host system at FNMOC via computer modem.

OPARS SUBSYSTEMS

OPARS is comprised of three sub-systems briefly described as follows:

- *OPARS User Interface:* Provides a communications interface for the OPARS user to generate and submit OPARS requests. This is primarily

accomplished at remote PC terminals or workstations (such as MIDDs) using conventional telephone lines. OPARS requests may also be submitted via the Internet and NIPRNET.

- *OPARS Data Base:* Consists of aircraft performance characteristics, route structure, and restricted area information required for the satisfactory performance of the OPARS program. The OPARS data base comes preloaded with each OPARS release. Keep in mind that updates to this data base are issued by FNMOC every 28 days and can be downloaded from the FNMOC website.

- *Flight Planner/Environmental Data Base:* The computer system at FNMOC produces a flight plan for the optimum route and performance parameters for each aircraft. Wind and temperature fields for flight level winds are produced twice daily and are derived from the FNMOC Naval Operational Global Atmospheric Prediction System (NOGAPS) forecast model. Wind and temperature data is available from 1,000 feet to 55,000 feet.

OPARS FLIGHT PLAN PROCESSING

The OPARS user is the individual interacting through a personal computer linked with the computer system at FNMOC. The OPARS user builds a flight plan request at the terminal and submits the flight plan request to the FNMOC computer for processing. The latest version of the system, OPARS 2.12, can run from any PC workstation, but is normally installed on MIDDs. This program operates using a Windows-based software program with a graphical interface. It allows users to build and *error-check* their flight plan request on their PC before submitting the job to FNMOC. OPARS 2.0 and later versions contain a built-in communication capability that can automatically access and log into FNMOC via commercial telephone, DSN, STU-III secure telephone, and INTERNET/NIPRNET.

Nearly every weather office accepts OPARS requests either over-the-counter or by telephone. Many individual military pilots are frequent users of OPARS, and these pilots may prefer to enter their own OPARS requests. However, most pilots prefer to have the base weather personnel process OPARS requests. The observer normally uses a locally prepared form to ensure that the necessary information is obtained, and then enters the information into the OPARS program. Each request must include information such as aircraft

type, point of departure, time of departure, point of arrival, number of different flight routes (legs), fuel weight, and air-routing type. After processing at FNMOC, the information is formatted into a flight plan and transmitted back to the office.

The OPARS program works with the Windows NT operating system or Windows 95. Users select the flight plan parameters by clicking on a series of menus. The program provides "help" menus that explain individual elements. A jet-route data base is included with the software and lets users visually work out air routes on their PC. Once selected, an air route can be saved for future use. These commonly used air routes are known as "canned" routes. Flight requests can also be saved and made available at a future time.

Once users obtain a flight plan from FNMOC, they can display it in many different formats, as a variety of tools are available to customize and enhance the display. Wind fields, navigational aids (navaids), and other features may be overlaid on any flight route. The flight plan is then downloaded to a printer and delivered to the pilot. Figure 2-6 is an example of just one of several OPARS input screens.

The Optimum Path Aircraft Routing System User's Manual, FLENUMETOCEN P-3710, provides detailed information for processing OPARS flight plans. This manual is published by FNMOC and is provided with MIDDs. It can also be downloaded from the FNMOC website. Information on how to interpret the different flight plan formats can also be found on the FNMOC website.

REVIEW QUESTIONS

- Q23. *What is the primary purpose of OPARS?*
- Q24. *Where is the OPARS data base located?*
- Q25. *What publication provides detailed information on processing OPARS requests and how can it be obtained?*

DATA REQUEST PRODUCT (DRP)

LEARNING OBJECTIVES: Identify how Data Request Products (DRPs) are obtained. Describe the various products that are available from the Data Request Product (DRP) system. Identify the publications that provide guidance on DRP products.

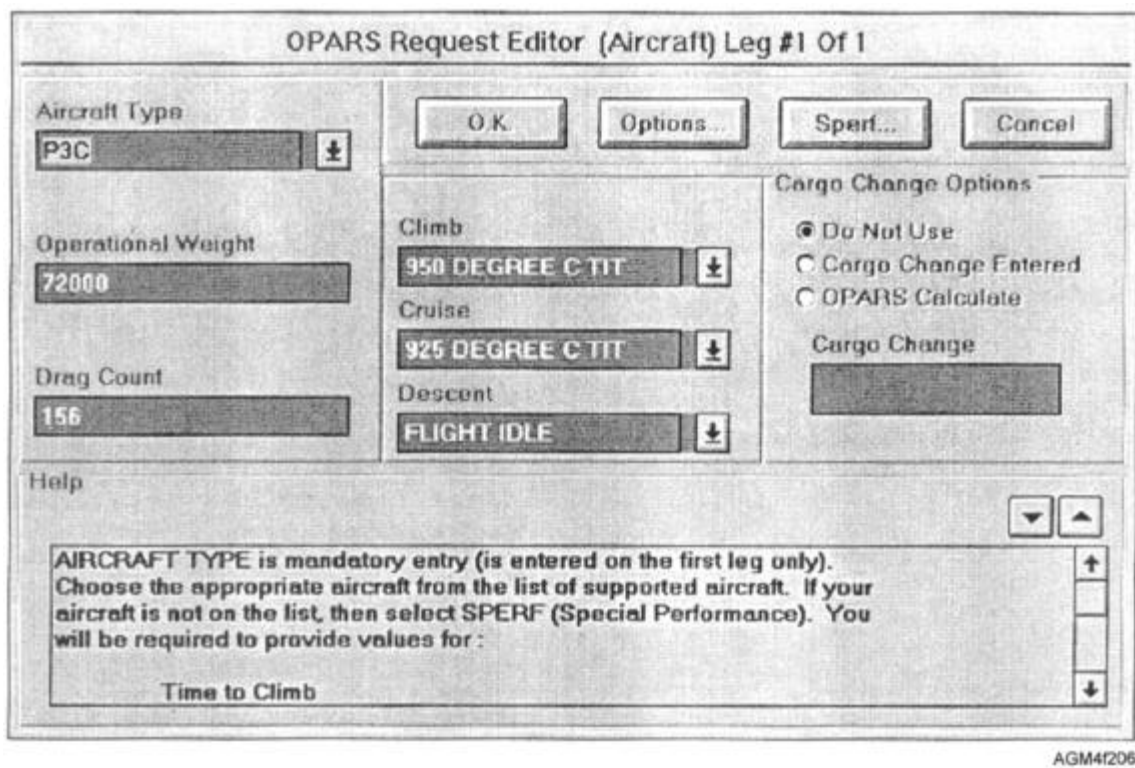

Figure 2-6.—OPARS input screen.

Data Request Products (DRPs) contain various computer-generated environmental information that is produced by the Fleet Numerical Meteorology and Oceanography Command (FNMOC) at Monterey. DRP products are usually requested only when locally produced environmental products are unobtainable. DRP products can be ordered via AUTODIN message or by telephone. AUTODIN requests are normally sent to the nearest regional center where the information is encoded in a special format and then retransmitted to FNMOC for processing. The collective address designator (CAD) *OCEANO WEST* or *OCEANO EAST* is used for all AUTODIN requests. Complete instructions for ordering DRP information as well as a breakdown of each product output can be found in the *DRP User Manual*, FLENUMETOCEN P-3146, and the *United States Navy Meteorological and Oceanographic Support System Manual*, NAVMETOCCOMINST 3140.1. The DRP Manual can be downloaded from the FNMOC website. Figure 2-7 is an example of an AUTODIN DRP request message.

```
O 311345Z AUG 98
FM USS NEVERDOCK
TO OCEANO WEST
BT
C O N F I D E N T I A L //N03140//
SUBJ: PRODUCT REQUEST (U)
1. Classification: Confidential
2. Product: BTXT
3. Time Period: 0000Z 02 SEP
4. Required NLT: 010600Z SEP 98
5. Area: 24.0N 141.0E, 22.0N 139.0E
6. Output: English
DECL/05 DEC 98
BT
```

Figure 2-7.—Sample AUTODIN DRP request message.

All DRP products are available for immediate processing and transmission from FNMOC via AUTODIN, NIPRNET/SIPRNET, and facsimile, 24 hours a day. We will explain the use of each DRP product in the following text.

SEARCH AND RESCUE PRODUCT (SAR)

The Search and Rescue (SAR) product is designed for open-ocean SAR situations and provides computer-generated historical (60 hour) and forecast (72 hour) outputs for probable error of position and search radius. SAR provides target location maps and search recommendations. It is available to all SAR coordinators for operational and training missions. FNMOC requires the following input from each SAR request: type of object, time object began to drift, latitude and longitude where object began to drift, and the estimated navigational error of the object's position. Average product turnaround time is less than 30 minutes from time of receipt to time of transmit at FNMOC.

BATHYTHERMOGRAPH DATA EXTRACT (BTXT)

The Bathythermograph Data Extract (BTXT) product provides bathy observations extracted from FNMOC synoptic data bases. The output consists of an alphanumeric product in the JJYY format in English or Metric units as desired.

ENVIRONMENTAL DATA LINES (ENVR)

The Environmental Data Lines (ENVR) product is a concise alphanumeric product that is used as input to onboard acoustic prediction systems. It provides a BT/SVP profile for a specific location, based on historical data. A BT or SVP observation may be provided as input by the user. This data is then blended with historical data to complete the profile from the surface to the ocean bottom. ENVR also provides the following information:

- Depth required/depth excess (DRX)
- Temperature gradient below sonic layer depth
- Low frequency/high frequency bottom loss
- Significant wave height
- Wind speed
- Bottom depth
- Sonic layer depth

GENERAL ENVIRONMENTAL MESSAGE (GEM)

The General Environmental Message (GEM) product provides the user with analyzed (synoptic) or forecast environmental data for specified locations or grid points (latitude/longitude) within an area. GEM data includes such products as pressure surface heights, wind direction and speed, altimeter settings, ditch headings, wave direction, wave period and height, freezing level data, and sea surface temperatures.

POINT DATA EXTRACT (PNTDT)

Point Data Extract (PNTDT) provides selected environmental data extracted from METOC model fields. Output for various parameters include marine wind speed, marine wind direction, sea surface temperature, significant wave height, primary and secondary wave period, and primary and secondary wave direction.

REFRACTIVE INFORMATION BY STATION (RIBS)

The Refractive Information by Station (RIBS) product provides an analysis of upper air soundings from requested upper air reporting stations. RIBS output provides pressure, temperature, dew point depression, M unit, gradient of M per 1,000 feet, and height and type of refraction. Users may choose up to 25 stations per request. RIBS data can be input into JOTS, TESS or IMOSS to extract on-site refractive products.

SPOUT OUTPUT (SPOUT)

Spout Output (SPOUT) provides surface land, surface ship, radiosonde, pilot balloon, aircraft, satellite infrared spectrometer, and/or hourly report observations extracted from the FNMOC data base in an easy-to-read format. Spout observations may be requested for a specific date and time and/or for a specific set of hours. Observation reports up to 72 hours prior to the current Date-Time Group (DTG) can be obtained.

OCEAN MODEL TEMPERATURE PROFILES (JJPRO)

The Ocean Model Temperature Profiles (JJPRO) was developed to provide computer-generated ocean analysis temperature profiles extracted from global

model vertical temperature profiles. JJPRO produces an alphanumeric product in the JJYY format. The profiles will extend from the surface to 400 meters or to the ocean floor depth, whichever is shallower. JJPRO may be requested for a grid area or for a specific latitude and longitude.

BALLISTIC WIND AND DENSITY (BALW)

The Ballistic Wind and Density (BALW) product provides surface-to-surface, surface-to-air, or rocket-assisted projectile forecasts for applications like naval gunfire operations. The product is a tabular listing of wind direction, speed, and air density for up to 15 altitude zones. It is derived from various atmospheric analysis and forecast data fields that can be combined with a user-provided upper air sounding.

SOUND FOCUSING (SNDFO)

Sound Focusing (SNDFO) provides atmospheric sound propagation loss for bomb blasts or sonic booms at selected altitudes and bearings. The output uses

alphanumeric characters to represent loss magnitude-out at specified ranges.

REVIEW QUESTIONS

- Q26. How are DRP products obtained?*
- Q27. What two publications contain information concerning DRP products output format?*
- Q28. What are the required inputs for an AUTODIN SAR request?*
- Q29. What is the purpose of the ENVR product?*

SUMMARY

We have provided just the briefest overview of the highly sophisticated software programs that you will use as an Aeroographer's Mate. Although several schools are available to provide instruction on the actual use of some of these programs, you will find that the manuals for these programs provide excellent instructions. In addition, the menu-driven command functions inherent in these programs will provide easy access and operability to even the most complex processing functions.

ANSWERS TO REVIEW QUESTIONS

- A1. *OAML provides consistency and standardization for all oceanographic and meteorological programs used by the Navy.*
- A2. *Naval Oceanographic Office, Stennis Space Center, Mississippi.*
- A3. *GF MPL provides meteorological, electromagnetic, oceanographic, hazard avoidance, and acoustic software for fleet air, surface, amphibious, and undersea warfare (USW) operations.*
- A4. *Geophysics Fleet Mission Program Library (GF MPL) Summary.*
- A5. *Analyses and predictions of GF MPL are based upon on-scene data, historical data, platform characteristics, and weapon/sensor characteristics.*
- A6. *The electromagnetic programs of GF MPL are used to predict radar performance (effectiveness) and calculate radar range.*
- A7. *Naval Search and Rescue (NAVSAR) and Tropical Cyclone.*
- A8. *The COVER program provides the capability to determine how an electromagnetic (EM) system will perform in either detecting or communicating with a given target or receiver.*
- A9. *The SSP program must be used with caution in situations where no BT data extends below 200 meters.*
- A10. *Internet access.*
- A11. *JMV, EOTDA, refractivity prediction programs, GF MPL, programs, and MIDD S application programs.*
- A12. *The TESS-NC Unix-based workstation is used to access the Global Command and Control System-Maritime (GCCS-M) and run the SP PED/ICAPS II Integrated Product (SIIP).*
- A13. *To assess the refractive effects upon naval surveillance, communications, electronic warfare, and weapon-guidance systems.*
- A14. *The most significant advantage of AREPS is that it can produce refractive effects predictions over land.*
- A15. *Visible, infrared, and laser.*
- A16. *EOTDA predictions are based upon meteorological forecasts, target characteristics, the components of the EO system, and tactics.*
- A17. *NODDS products are normally obtained using standard telecommunications circuits (commercial/DSN/STU-III). They may also be obtained via NIPRNET and Email.*

- A18. *NODDS meteorological products include surface pressure, pressure heights, and high wind/high seas warnings. NODDS oceanographic products include sea/swell data, sea surface temperature data, and various acoustic path range products.*
- A19. *A significant processing advantage of NODDS is that it allows users to define an area of interest and display different types of data for that area.*
- A20. *JMV products are obtained via the NIPRNET*
- A21. *The FNMOC website.*
- A22. *JMV defined areas are defined by the regional METOC centers and by FNMOC*
- A23. *The primary purpose of OPARS is to provide a flight planning service to the Naval Aviation community that minimizes time enroute and fuel consumption.*
- A24. *The OPARS data base is located at the user's PC terminal (normally MIDDs).*
- A25. *The Optimum Path Aircraft Routing Systems User's Manual P-3710. This can be obtained from the FNMOC website.*
- A26. *DRP products can be ordered via AUTODIN message or by telephone.*
- A27. *DRP User's Manual, FLENUMETOCEN P-3146, and United States Navy Meteorological and Oceanographic Support System Manual, NAVMETOCCOMINST 3140.1.*
- A28. *Type of object, time object began to drift, latitude/longitude where object began to drift, and the estimated navigational error of the object's position.*
- A29. *The ENVR product is an alphanumeric BT/SVP profile that can be used as input to onboard acoustic prediction systems.*

CHAPTER 3

ADMINISTRATION

INTRODUCTION

As an Aerographer's Mate, you must be able to locate various information in files, directives, and publications. You may be tasked to maintain a set of files or to update publications or directives. In this chapter, we begin with a discussion of some administrative terminology. We then cover a few basic procedures you must use to maintain files, directives, and publications. Finally, we discuss methods for obtaining information.

GENERAL ADMINISTRATION TERMINOLOGY

LEARNING OBJECTIVE: Define the terms *file, record, directive, instruction, notice, change transmittal, publication, chart, and form.*

Before we discuss techniques on locating information and maintaining informational resources, we must define a few general terms used in administration.

- *File.* A file is a collection of information, usually organized by subject, which includes information or material about the subject. Information may be original written material or reproduced copies, and may be in the form of notes, rough drafts, final print, or published information. A file may also contain material such as art, drawings, photographs, magnetic media (tapes, floppy disk, hard disk, etc.), light media (films, transparencies, etc.), samples, models, prototypes, or evidence. A file may also contain records.

- *Record.* As officially defined by the United States Government, records include "all books, papers, maps, photographs, machine-readable materials, or other documentary materials, regardless of physical form or characteristics, made or received by an agency of the United States Government under Federal law or in connection with the transaction of public business, and preserved, or appropriate for preservation, by that agency or its legitimate successor, as evidence of the organization, functions, policies, decisions, procedures,

operations, or other activities of the Government, or because of the informational value of the data in them. Library and museum material made or acquired or preserved solely for reference or exhibition purposes, extra copies of documents preserved only for convenience of reference, and stocks of publications and of processed documents are not included."

- *Directive.* A directive is a written statement that officially prescribes or establishes policy, methods, or procedures. It may require action or simply provide information for an activity's administration or operation. A directive has the effect of orders issued by the signing authority. Directives are issued as instructions, notices, and change transmittals.

- *Instruction.* An instruction is a directive containing authority or having a continuing reference value, or requiring continuing action. It remains in effect until superseded or canceled by the originator or higher authority. In the Marine Corps, instructions are referred to as *orders*.

- *Notice.* A notice is a directive of a one-time or brief nature that contains a self-canceling provision. Notices have the same force as instructions. Notices usually remain in effect less than 6 months, and, by definition, should not be effective for longer than 1 year. Notices are called *bulletins* in the Marine Corps.

- *Change Transmittal.* A change transmittal is a written set of directions used to correct, update, or modify an existing instruction. Although not normally done, change transmittals may also be used to correct notices. Each change transmittal describes the nature of the changes it transmits, and gives directions for completing them.

- *Publication.* Publications include any pamphlet, book, or collection of information, other than a directive, reproduced by mechanical methods by the Government or a private agency for distribution within the Government or to the public.

- *Chart.* A chart includes any map, drawing, or diagram depicting information. In this chapter, we will be referring to weather plotting charts (printed maps used to plot weather data), computer-produced printouts, facsimile charts (facsimile reproductions of

plotted and analyzed weather products), and recorder charts (machine plotted traces of record information).

- *Form.* These are preprinted paper documents that use blank lines or spaces for the entry of information.

REVIEW QUESTIONS

- Q1. *How are files normally organized?*
- Q2. *What term is used to describe a written statement that officially prescribes or establishes policy, methods, or procedures?*
- Q3. *By definition, notices are only effective for what maximum period of time?*

ORGANIZATION OF FILES, DIRECTIVES, AND RECORDS

LEARNING OBJECTIVES: Describe how files, directives, and records are organized. Identify the basic format of the Standard Subject Identification Code (SSIC). Identify the directive that contains instructions for assigning SSICs. Identify the directive that lists effective instructions for major naval commands.

In the Navy, both files (which may contain official records) and directives are organized according to the Standard Subject Identification Code (SSIC) system. The reference manual used to assign codes for specific subjects is SECNAVINST 5210.11, *Department of the Navy File Maintenance Procedures and Standard Subject Identification Codes* (SSIC), often referred to as the SSIC manual. Instructions are provided to help you assign a code for any subject. The instruction states that all Navy and Marine Corps letters, messages, directives, forms, records, and reports should be assigned an SSIC by the originator. The SSICs are used as the basis for filing all information received or originated as letters, messages, directives, etc.

There are thirteen major subject groups in the SSIC system, each designated by the thousands digit(s) in a four- or five-number code, as shown in table 3-1.

Each major subject category is broken down into *primary subjects*, as identified by the hundreds digit of the code. The primary subjects are then broken down into *secondary subjects*, as identified by the tens digit in

Table 3-1.—Major Subject Groups of the SSIC

CODES	MAJOR SUBJECT GROUP
1000 to 1999	Military Personnel
2000 to 2999	Telecommunications
3000 to 3999	Operations and Readiness
4000 to 4999	Logistics
5000 to 5999	General Administration and Management
6000 to 6999	Medicine and Dentistry
7000 to 7999	Financial Management
8000 to 8999	Ordnance Material
9000 to 9999	Ships Design and Material
10000 to 10999	General Material
11000 to 11999	Facilities and Activities Ashore
12000 to 12999	Civilian Personnel
13000 to 13999	Aeronautical and Astronautical Material

the code. The last digit in *the code* reflects a *tertiary* (third) subject. The SSIC manual assigns codes through the secondary subjects in all cases, and through the tertiary subjects in many cases. Codes may be assigned locally by using numbers following a decimal point to further break down or classify a subject. As an example, the code used for NAVMETOCCOMINST 3142.1 represents the major subject group 3000, for *Operations and Readiness*; the primary subject 100, *Operations*; the secondary subject 40, for *Geophysical and Hydrographic or Mapping, Charting, and Geodesy Support, General*; and the tertiary subject 2, for *data collection*. NAVMETOCCOM assigned the decimal .1 to identify Pilot Weather Reports (PIREPS). Letters following the last digit, such as 3142.1A, are used to indicate periodic revisions of instructions. The letters are used in sequential order.

You will rarely be required to assign an SSIC to a subject. All incoming naval message traffic and most naval correspondence will contain an SSIC. In message traffic, the SSIC is the five-digit number within double slants following the message classification. You may have seen observations before that have contained the classification line **U N C L A S //N03141//**. The N means a U.S. Navy SSIC follows, and the 3141 is the SSIC. In naval messages, the code is always expressed as a five-digit number, and only codes down to the tertiary subject-level are used.

All naval letters and some memoranda will contain SSICs. Naval letters will contain a four or five-digit SSIC as the first entry in the identification information on the top right side of the page following the letterhead. Figure 3-1 is an example of the standard naval letter format.

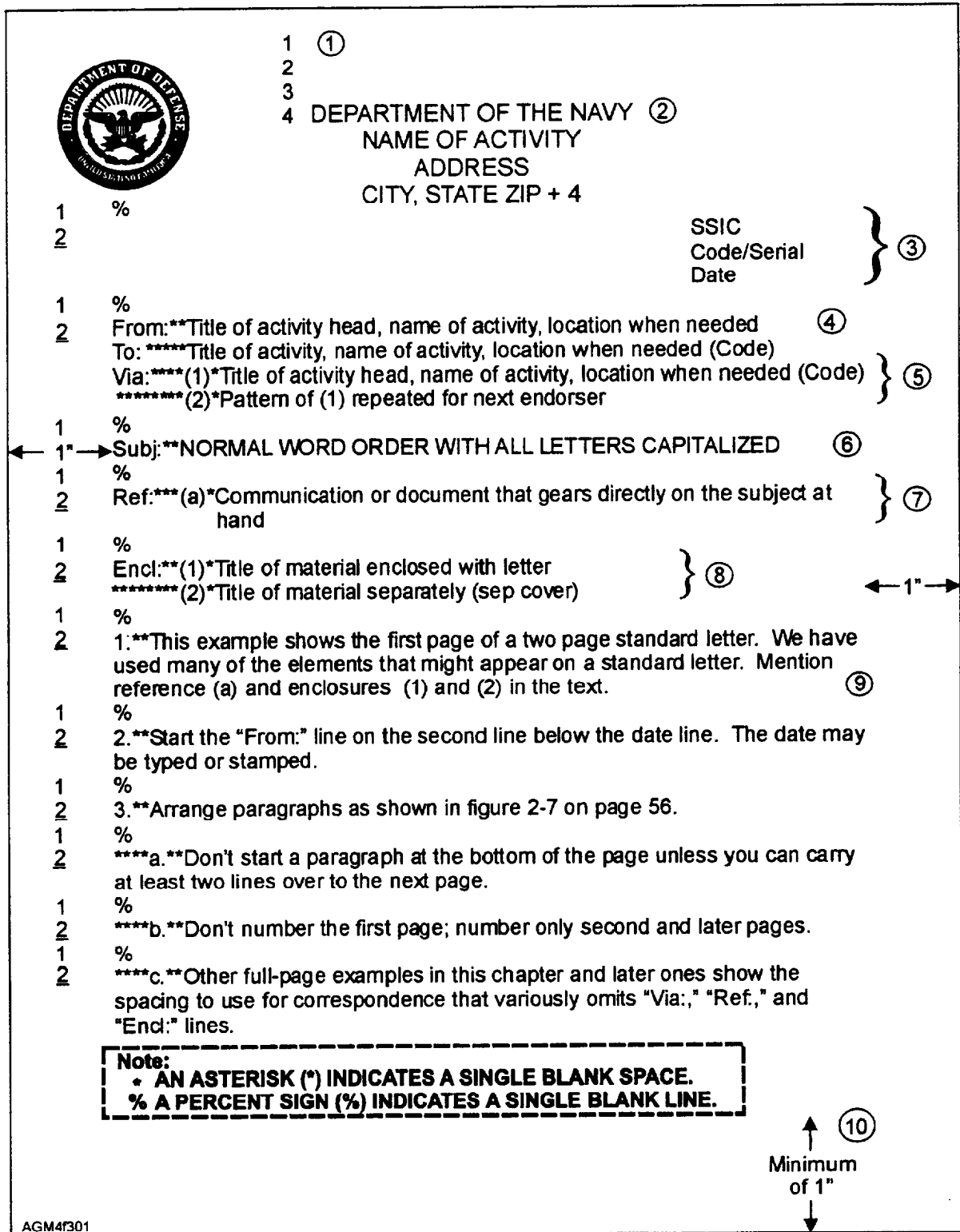

- | | | | | |
|----------------------|---------------------------|---------------------|-------------------|-------------|
| 1. Typewriter Lines | 3. Identification Symbols | 5. To and Via Lines | 7. Reference Line | 9. Text |
| 2. Letterhead Format | 4. From Line | 6. Subject Line | 8. Enclosure Line | 10. Margins |

Figure 3-1.-Standard naval letter format (first page).

REVIEW QUESTIONS

- Q4. *What would be the major subject group of an instruction with an SSIC of 5510?*
- Q5. *In reference to the SSIC 3140.IJ what does the letter J indicate?*
- Q6. *What reference provides a detailed listing of effective instructions for major naval commands?*

GENERAL RECORD MAINTENANCE

LEARNING OBJECTIVES: Identify the tasks involved with the maintenance of records. Define the terms *permanent record*, *temporary record*, *cutoff date*, and *retention period*. Identify basic storage procedures for records. Identify the instruction that provides guidance for the disposition of records.

Many of the files at your command are classified as official records. These records include such things as command history, surface weather observation data, upper air observation data, and bathythermograph data. When you are given the job of maintaining a set of records, more is involved in the job than just stuffing paperwork into drawers of a filing cabinet. In this section, we will describe the different types of records, and then discuss storage and disposal procedures.

TYPES OF RECORDS

Records are normally contained in file folders that are designed to hold information accessible for reference. The length of time that material is held is determined by the type of information. The Secretary of the Navy has defined two basic types of informational material based upon the importance of the information for future applications. These two informational types, *permanent records* and *temporary records*, are explained in the following text.

Permanent Records

Permanent records are informational material and records necessary to protect the Navy's interest and to insure proper documentation of the Navy's significant experiences, primary missions, functions, and responsibilities. Permanent records may be of research legal, historical, or scientific value. In the

Of the seven naval memorandum formats, the two formats that are routinely used for intercommand memoranda are the *letterhead memorandum*, printed on the command's letterhead paper (fig. 3-2), and the *memorandum* for, also printed on the command's letterhead. Both of these formal memoranda formats must contain a SSIC in the same manner as the naval letter. You may use assigned SSICs as the basis for tiling the material, if tiling is required.

The two informal memoranda formats, used only for intracommand (interoffice) memos, normally do not contain SSICs. Often, the informal memoranda contain information of little continuing value, and rarely require filing. Usually, informal memoranda are hung on clipboards or placed in binders until the event listed in the memo passes, and then the memo is destroyed. Instructions for composing naval letters and memorandums are contained in SECNAVINST 5216.5D, *Department of the Navy Correspondence Manual*.

The SSIC manual should be used as the basic guide for assigning codes to subjects when SSICs have not previously been assigned. For convenience of use, the SSIC manual is broken down into a numerical, code-to-subject section as well as an alphabetical, subject-to-code section. However, the manual often does not assign codes in sufficient detail to cover every subject. By using the group, primary subject, secondary subject, and (if provided) tertiary subject codes as guidance, refer to your commands instruction index to locate instructions with the same SSIC code for the subject you are attempting to classify. You will often find a notice or an instruction dealing with the subject, and these directives will have a subject-specific SSIC. Keep in mind that it is not uncommon to find many subdivisions of a tertiary code using decimal codes from .11 to .99.

The directive, *OPNAV NOTE 5215*, updated semiannually, lists not only effective Naval Meteorology and Oceanography Command instructions, but instructions for all of the major naval commands. It contains four sections of listings: Part I, an alphabetical listing of instructions, by command; Part II, a numerical listing of instructions, by command; Part III, a cancellation listing, by command; and Part IV, a DOD implementation listing. The numerical listing under "METOCCOM" provides a complete list of effective Naval Meteorology and Oceanography Command instructions.



DEPARTMENT OF THE NAVY
NAVAL AIR FACILITY
DETROIT, MI 48045-5008

5216
Memo 28/83
5 Jan 99

1
2

1
2

MEMORANDUM

1
2

From: Head, Management Services Department, Naval Air
Facility, Detroit
To: Operations Officer, Navy Regional Data Automation
Center, San Francisco

1
2

Subj: LETTERHEAD MEMORANDUM

1
2

1. When used within an activity, the letterhead memorandum provides more formality than the printed memorandum form of the plain-paper memorandum.

1
2

2. A letterhead memorandum may be sent outside your activity if:

- a. Direct liaison is authorized.
- b. The matter is routine.
- c. The memo neither makes a commitment nor takes an official stand.

1
2

3. Generally follow the standard letter format, but type "MEMORANDUM" as shown here.

1
2
3
4

E. F. GEE

AGM41302

Figure 3-2.—Letterhead memorandum format.

meteorological and oceanographic (METOC) community, most of the data collection information falls into this category. This includes surface weather, upper-air, and bathythermograph observation record sheets, and also includes any data diskettes and recordings taken by observers. Just as important are research and program development files, and the trip

reports filed by returning Mobile Environmental Team (MET) members. Many operation and exercise support files and command history files also contain permanent record information. Usually, permanent record material is original material produced by the personnel at your command, but not all original material is permanent record material.

Temporary Records

This is informational material that has little long-term value or significance but is necessary for routine or short-term use. A few examples of temporary material frequently found in the METOC community are training reports, inventories, and general correspondence. Most material you file that is a *copy* of other material (copies of charts, messages, letters, technical information or magazine articles, and publications or pamphlets) may be considered temporary material.

Files for a specific subject may contain mixed material, both permanent-record information and temporary-record information. Files that contain predominately permanent-record information are permanent files. Permanent files may contain copies of temporary information that directly relates to the information in the file, or supports the work or research. Temporary files should contain mostly temporary-record information. Any information of permanent value in a temporary file must be separated from the file when the temporary information is destroyed.

STORAGE OF RECORDS

Files are normally held in drawers of filing cabinets or safes, and separate file folders are used to contain each subject (record) file. Use of a specific type of file folder may be designated by the command or left to the user's choice. For ease of finding and retrieving material, however, similar size folders should be used in each set of files.

Most shipboard and shore-based METOC activities receive computer-produced charts, AUTODIN message reports of ship observations, National Weather Service (NWS) products and bulletins, and facsimile charts. They also produce original (outgoing) meteorological and oceanographic support products. Few of these products are routinely stored in what is typically thought of as a set of files. Most likely, the smaller size paper products are sorted by type and date and stored in expandable envelopes, and the larger size original charts and facsimile charts are stored in map drawers or chart cabinets. Many of these products, regardless of the method or location of storage, are *official records* and must be properly maintained, just as any other material kept in file folders in safes and filing cabinets is properly maintained.

DISPOSAL OF FILES/RECORDS

Most files and/or records are maintained on an annual basis. A separate set of file folders is used for each year's files. Usually, file subject titles and SSICs are duplicated on the new file folders. While most files start at the beginning of the calendar year (January 1) and are closed out at the end of the calendar year (December 31), fiscal files (or files dealing with budgeting, supply, or other money matters) are opened at the beginning of the fiscal year (1 October) and are closed at the end of each fiscal year (September 30). The date that files *are* closed is known as the *cutoff date*. No new material dated after the cutoff date should be placed in a file after the cutoff date. Material originated after the cutoff date should be placed in the next year's set of files.

After the cutoff date, files must be held for a prescribed period of time based on the type of information they hold. This period of time is known as the *retention period*. Most material held in files at METOC activities have retention periods of 1 or 2 years. To determine the proper retention period for material in your files, you must consult SECNAVINST 5212.5, *Navy and Marine Corps Records Disposition Manual*.

Permanent records, with the exception of observation records, should be transferred to the Federal Records Center after the retention period has passed. Specific instructions for handling the transfer of meteorological and oceanographic observations are provided in NAVMETOCCOMINST 3140.1, *United States Navy Meteorological and Oceanographic Support System Manual*. All temporary records and files should be properly disposed of or destroyed after the retention period has elapsed.

REVIEW QUESTIONS

- Q7. *Records that contain information of research, legal, historical, or scientific value are classified as what type of records?*
- Q8. *Inventory records are classified as what type of records?*
- Q9. *What would most likely be the cutoff date for a file containing budgetary information?*
- Q10. *Where would you find information pertaining to the retention period of weather maps and charts?*

MAINTENANCE OF FILES AND DIRECTIVES

LEARNING OBJECTIVES: Identify the tasks involved with the maintenance of files and directives. Identify methods for obtaining directives. Explain the use of Change Transmittals.

In this section, we will explain how to maintain files and directives, how to obtain directives, and finally, how to process change transmittals.

MAINTAINING FILES

The following are some of the most important tasks involved with proper filing system maintenance:

- Inventory the current filing system to ensure the index of your files is up to date. For each file you maintain, the index should contain the file subject title, the SSIC, a specific cutoff date, the retention period, and the transfer or disposal date. Do not include unnecessary working papers, early drafts, extra copies, or information material as part of the file material.

- Obtain some type of receipt from all personnel removing files from the filing cabinet. This will simplify locating files that later turn up missing. The receipt should document the name of the person removing the file, their office or phone number, and an approximate length of time the file will be absent from the storage container. You may use a computer file, a logbook, 3 × 5 cards, or slips of paper for the receipt, as long as you can keep track of the location of all of the files.

Ensure all files in your filing system are properly marked on the outside with the subject title, SSIC, cutoff date, retention period, and the transfer or destroy date.

- Establish new files as necessary.
- Arrange file folders in SSIC order.

- Place incoming information in proper subject files in date/time order, oldest on the bottom. Most people maintaining files in the METOC community prefer to use paper prongs to hold papers securely in each file, although this practice is not required.

- Close out files at the cutoff date and replace with new file folders (properly labeled) as necessary.

- Keep closed out files together in a safe, weatherproof location. Normally, closed-out files are maintained in the original office if space permits. Maintain closed-out files for the required retention period.

- Destroy temporary material at the end of the retention period. Keep in mind security considerations. Shred, pulp, or burn classified and "For Official Use Only" material.

- Transfer permanent records in accordance with instructions in SECNAVINST 5212.5 and NAVMETOCCOMINST 3140.1 at the end of the retention period.

MAINTAINING DIRECTIVES

All Naval Meteorology and Oceanography Command activities and all naval ships staffed with Aerographer's Mates are required to maintain directives issued by the Commander, Naval Meteorology and Oceanography Command. Aboard ships, the instructions are sometimes maintained in the ship's administration office, but more often than not, they are maintained in the geophysics office.

You will also need to maintain selected instructions from the Office of the Secretary of the Navy (SECNAV), Bureau of Naval Personnel (BUPERS), Office of the Chief of Naval Operations (OPNAV), and the Commander in Chief, Atlantic/Pacific Fleet (CINCLANTFLT/CINCPACFLT). At the Naval Meteorology and Oceanography Command centers and facilities, you will also maintain a set of your center's or facility's directives.

Most of the instructions and notices your office maintains are only a few pages long. Others may be 1- or 2-inch thick manuals. Usually, all but the thickest directives are placed in standard, government-issue, three-ring binders, and stored in some type of bookcase. With the exception of certain classified instructions, which must be stored in a secure container, all instructions from a series should be kept together. The binders should be labeled so that the other people you work with can find the instructions easily. All directives within a set are arranged in SSIC order, from the lowest number to the highest number. Recently, most SECNAV, OPNAV, and BUPERS instructions have been made available on CD-ROM, and only the directives you require need to be printed. However, these CD-ROM disks should be maintained in a similar fashion.

The first task you must do when you are assigned the job of maintaining any set of directives is to inventory the instructions and notices currently on board, and make note of any that are missing. As previously discussed, OPNAV NOTE 5215 lists effective instructions. A quick look around the spaces may turn up frequently used instructions that are missing. Also check that overflowing incoming basket on your desk (or the LPO's desk) to insure that the missing directives are not in-house, awaiting filing.

If a directive is normally held in some location other than the directives binder, a locator cross-reference sheet should be filled in and filed in the location the directive would normally occupy in the binder. Most manual-like directives contain a preprinted locator cross-reference sheet immediately following the distribution list in the front of the instruction. Sign-out cards or some similar system should be used when directives are temporarily removed from the binders for any reason.

Make note of any instructions that are obsolete. If the manual lists 3143.1F as the current instruction and you have 3143.1E, you will need to obtain 3143.1F. Identify the 3143.1E edition in the binder as being obsolete by writing *superseded by 3143.1F* across the top of the first page in red ink. Do not destroy the old instruction until you have received the updated version. Many times, much of the information in the old instruction will still be valid.

Obtaining Directives

Order any instructions that you are missing. OPNAV NOTE 5215 marks all instructions that are available directly from the originator with an asterisk (*). All others must be ordered from the Naval Inventory Control Point (NAVICP) in Philadelphia. The Naval Supply Systems Command issues the *Naval Logistics Library (NLL) User Guide* (NAVSUP Publication 600) as a four CD-ROM set. The first CD contains NAVSUP Publications P2002, which lists stock numbers for all instructions stocked at the Naval Inventory Control Point. These CD-ROMs can also be ordered via the Internet at the NLL web address: <http://www.nll.navsop.navy.mil>.

In addition, the Office of the Secretary of the Navy and the Office of the Chief of Naval Operations have developed an Internet website called the "Navy Electronic Directives System." This website provides the quickest method for obtaining most unclassified SECNAV and OPNAV directives. The site contains

listings of new and canceled directives, as well as directions for ordering complete CD-ROM sets of directives. You may also download several SECNAV and OPNAV forms. The website is actually maintained by the Defense Automated Printing Service Office in Philadelphia, and can be reached by using the URL: <http://neds.nebt.daps.mil>.

As you receive new or updated directives, file the directives in their proper locations in the binder by SSIC. Remove and destroy the outdated directives.

Processing Change Transmittals

Many instructions are updated with change transmittals. Change transmittals provide a simple method to make small changes to directives as they occur. Each change transmittal identifies the instruction to which it applies, and lists several types of changes that must be made to the instruction to update it.

Many times, change transmittals will contain replacement pages, which must be inserted in the place of the old same-numbered pages in the instruction. These are *page* changes. Change transmittals may also list words or passages that must be entered in pen in specified places. These are called *pen changes*. Occasionally, a change transmittal will contain a printed paragraph and will call for the new paragraph to be cut out of the change and taped or pasted over an existing paragraph in the instruction. This is called a *paste-in change*. Yet another type of change that may be used is a *repetitive change*. This type of change is usually a blanket statement, such as "replace the words Naval Oceanography with Naval Meteorology and Oceanography throughout this instruction." This type of change does not specify the location of the required changes. Unless specifically stated otherwise, repetitive changes are not actually made throughout the instruction. The change transmittal containing the repetitive change is filed at the beginning of the basic instruction; the repetitive change statement may be highlighted to catch the reader's eye.

Regardless of the number of changes specified, you must follow the list of change instructions exactly as described. You should check off each change instruction as you complete the change. Changes should be entered in the appropriate instructions as soon as change transmittals are received, and should not be shunted to a hold basket to collect dust. Changes should be made to all copies of the instructions held, not just the copy normally held in the binder. Usually, the changes

listed in change transmittals are effective as of the publishing date (the date listed on the transmittal), and will have been in effect for several weeks by the time you receive the change transmittal.

After the necessary changes have been made to the instruction, you must enter the change information on the *Record of Changes* page, located in the front of most instructions. This page, ruled in columns and lines, requires entries of (1) the change number (change 1 or CH1, for example), (2) the date the change was issued, (3) the date the change was actually entered, and (4) the name (not initials) and rate of the person entering the change.

In summary, to properly maintain a set of directives, you must accomplish the following tasks:

- **INVENTORY** all directives, making note of missing or out-of-date directives.
- **ORDER** replacements for missing or obsolete directives.
- **FILE** new and revised directives as they are received.
- **ENTER CHANGES** documented in change transmittals, as they are received.
- **COMPLETE** locator cross-reference sheets for all directives held in locations other than the proper directives binder.
- Use a **SIGN-OUT** system for all borrowed directives.

REVIEW QUESTIONS

- Q11. *What type of information should be contained on the outside of each file folder?*
- Q12. *What is the first task you must do when maintaining a set of directives?*
- Q13. *What is the purpose of a cross-reference sheet?*
- Q14. *What is the fastest way to obtain unclassified SECNAV and OPNAV directives and instructions?*
- Q15. *What is the purpose of change transmittals?*

MAINTENANCE OF METEOROLOGICAL AND OCEANOGRAPHIC PUBLICATIONS AND FORMS

LEARNING OBJECTIVE: Identify the tasks involved with maintenance of meteorological and oceanographic publications and forms.

So far, we have discussed the maintenance of tiles and directives. Two other administrative functions you may be asked to do are to maintain meteorological and oceanographic reference publications, and to maintain meteorological and oceanographic forms.

TYPES OF PUBLICATIONS

As you have probably discovered, every METOC office, whether aboard ship or ashore, has many different reference publications available for use. Some offices receive and maintain specialized magazines dealing with the sciences of meteorology and oceanography, such as *Weather-wise* or *Bulletin of the American Meteorological Society*. Nearly every METOC activity has been issued several different NAVAIR publications. These are books published by the government or civilian publishing companies that the Naval Air Systems Command determined to be useful for reference. Other publications you might have in your office are equipment technical manuals and operator manuals that were issued with various pieces of equipment.

Required Publications

Required publications are the hard- or soft-covered books that you must have on hand, as directed by proper authority. *Required* publications for Navy and Marine Corps METOC support activities are defined in the *Master Publications Allowance List*, published by the Naval Oceanographic Office. This listing contains detailed information on all publications that are required for each type of METOC activity, such as centers, detachments, aircraft carrier OA divisions, and so forth. The Master Publications Allowance List contains information on the source of each of the publications listed, the agency responsible for updating the publication, and the agency that publishes and distributes the publication. It also lists the issue date, the revision date, classification, and the national stock number (NSN). Publications applicable to specific

warfare areas, such as Undersea Warfare or Amphibious Warfare are also provided. The Master Publications Allowance List is available from the Naval Oceanographic Office on CD-ROM. It can also be downloaded via the Secure Internet Protocol Routing Network (SIPRNET).

Useful Publications

Useful publications include those publications that, although useful, are not required for inspection purposes. These publications include climatology studies, National Weather Service publications, and certain classified publications. Appendix III of NAVMETOCCOMINST 3140.1, U.S. Navy *Oceanographic and Meteorological Support System Manual*, lists several pertinent references for oceanographic and meteorological support. These consist of different instructions and publications that contain information especially useful for different METOC-related tasks. However, the appendix stresses that the list is not a list of required publications.

Unclassified Naval Oceanographic Office publications are listed in the NAVOCEANO RP-50, *Catalog of Naval Oceanographic Office Publications*. Classified Naval Oceanographic Office publications are listed in the NAVOCEANO RP-51(S), *Catalog of Classified Naval Oceanographic Office Publications*. Source listings for NAVAIR publications, airfield summaries, and observation summaries are discussed in the following text.

Climatic Publications

The National Weather Service, the Air Force, and the Navy all produce various types of climatic studies and climatic summaries. Many of these products are routinely distributed to your command via CD-ROM as they are produced. Some products must be specially ordered. The best place to find out what type of climatic information is available for a specific location or region is the Fleet Numerical Meteorology and Oceanography Detachment (FNMOD), Asheville Internet website at: <http://waves.ncdc.noaa.gov>. This site contains information on climatic reference publications and studies available on CD-ROM as well as in book form. It also provides a listing of several climatic studies that are currently available for issue on different types of media-paper, microfiche, microfilm, or compact disk. It does not list any classified studies that may have been made for any particular location. The FNMOD website also provides a listing of available *Worldwide Airfield*

Summaries (WWAS) and *Summary of Synoptic Meteorological Observations (SSMOs)*.

MAINTENANCE OF PUBLICATIONS

So far, we have discussed several sources that list publications that may be found in your office. Now we will discuss how to take care of the publications that you have.

The Naval Meteorology and Oceanography Command centers and facilities may have rooms that are designated as a library, but for most detachments and ships, this is a luxury because of space limitations. Undoubtedly, you have some bookcase space available, whether aboard ship, in a detachment, or at a center or facility. If your command has an established system for filing and retrieving publications, and the system generally works, then the best thing you can do is to learn that system and work with it.

If no workable system has been established, the simplest system for office-size book collections is the alphabetical filing system. File the publications on shelves in alphabetical order by the title. A computer listing (or index cards) should be made up for each book, listing the title, publication number, and subject(s) covered.

For slightly larger collections of publications, you may wish to divide the bookcase shelves into sections for each series of publications, such as NAVAIR publications (all publications with NAVAIR numbers), National Weather Service publications, Naval Oceanographic Office publications, Naval Environmental Prediction Research Facility publications, and so forth. Publications within each group may be arranged alphabetically. The same type of title and subject computer listing (or index card listing) may be maintained, but each entry should also include a listing of the bookcase section in which the publication is located.

Your title index and subject index are the key to your library. Keep the index current. Let the other people you work with know how the publications are arranged and how the index is maintained. If the index is maintained on the office computer, let them know how to access the information, or be available to access the information for them.

Some sort of checkout system or log must be used to keep track of publications that are removed from the area. The most useful reference publications, if not controlled properly, tend to "disappear" from libraries.

These publications may sometimes be located on someone's desk; but without a checkout system, larger commands must reorder publications frequently.

As for the publications themselves, all books should be kept in a dry, low-humidity environment. High humidity and moisture promote mold growth, which destroys the paper. Books should not be exposed to strong or direct sunlight. Sunlight yellows the edges of the pages and accelerates paper decomposition. It also makes the binding brittle.

Aboard ship, it is common practice to box up and store publications that are not expected to be especially useful during an upcoming cruise, in an out-of-the-way location. The computer listing or index cards of books stored in this manner should be annotated with the storage location.

MAINTENANCE OF CHARTS AND FORMS

The use of Department of Defense weather plotting charts has been on a steady decline since the introduction of computers into the weather field. Most ships staffed with Aerographer's Mates are still required to maintain these charts. During predeployment, chart inventories are taken aboard ship and a count of the type and quantity of plotting charts is made. Based upon past usage of each chart, the monthly usage of each type of chart should be calculated. Shipboard personnel must not only estimate the monthly usage of each type of chart, but also consider the types of charts that may be necessary for various contingencies. Charts not normally used in routine operations may suddenly become important in different operational scenarios. Check with your LPO or LCPO for guidance.

Keep in mind that all ships and stations should still keep a 90-day supply of weather plotting charts. Weather plotting charts (WPCs) are supplied by the National Imagery and Mapping Agency (NIMA). Detailed instructions for completing one-time orders or establishing automatic distribution are contained in the

Department of Defense, National Imagery and Mapping Agency Catalog of Maps, Charts, and Related Products, Part I-Aerospace Products. Information concerning NIMA products can be obtained via the Internet at: <http://www.nima.mil>.

Most METOC forms are now locally produced, and you should make sure there is a ready supply. Some forms, such as weather observation forms, must still be ordered via normal supply channels using national stock numbers. Details for ordering these forms are contained in NAVMETOCCOMINST 3140.1. Certain forms, such as the Station Information File (SIF), can be downloaded from the FNMOD website.

REVIEW QUESTIONS

- Q16. Where can you find information regarding publications that are required at your command?*
- Q17. Where can you find information pertaining to classified Naval Oceanographic Publications?*
- Q18. Where is the best place to find out what climatological information is available for a specific region?*
- Q19. Weather plotting charts are supplied by what agency?*

SUMMARY

In this chapter, we have discussed some of the basic terminology associated with administration and explained the basic organization of files, directives, and records. We also discussed general record maintenance and the maintenance of files and directives, including how to obtain directives and how to process change transmittals. We completed the chapter with a discussion of the maintenance of meteorological and oceanographic publications and forms.

ANSWERS TO REVIEW QUESTIONS

- A1. *According to subject.*
- A2. *A directive.*
- A3. *1 year.*
- A4. *General Administration and Management.*
- A5. *A revision of the instruction.*
- A6. *OPNAV NOTE 5215.*
- A7. *Permanent records.*
- A8. *Temporary records.*
- A9. *30 September.*
- A10. *SECNAVINST 5212.5.*
- A11. *Each file should contain the file subject title, the SSIC, a specific cutoff date, the retention period, and the transfer or disposal date.*
- A12. *Inventory the instructions and notices currently on board, making note of any that are missing.*
- A13. *Cross-reference sheets are used to indicate the location of directives, that for whatever reason, are not held in the directives binder.*
- A14. *The "Navy Electronic Directives System" on the Internet.*
- A15. *Change transmittals provide a simple method to make small changes to directives as they occur.*
- A16. *The "Master Publications Allowance List" published by the Naval Oceanographic Office.*
- A17. *The Catalog of Classified Naval Oceanographic Office Publications, RP-51(S).*
- A18. *FNMOD Asheville Internet website.*
- A19. *The National Imagery and Mapping Agency (NIMA).*

APPENDIX I

GLOSSARY

A

ACTIVE USW—A method for determining the location and distance of a submarine by measuring the time interval between the transmission of a sound signal and its reflection back to the projector.

AEROSOLS—Small droplets (solid or liquid) suspended in a gas.

AFMEDS—Air Force Meteorological Data System.

AFWA—Air Force Weather Agency headquartered at Offutt AFB, NB.

AIG—Address indicator group.

ALGORITHM—A step-by-step procedure for solving a mathematical problem.

ANALOG—Proportional and continuous. An analog recorder draws continuous lines proportional to the electronic signal input.

AOR—Area of responsibility.

APT—Automatic picture transmission. The automatic transmission of images by polar-orbiting satellites.

ARQ—Automatic response to query. A method of obtaining data using AFMEDS.

ASOS—Automated surface observing system.

AUTODIN—Automatic digital network:

AWN—Automated weather network; the complex worldwide collection and distribution network of meteorological data operated by the Air Force.

AZIMUTH—The horizontal angular measurement from a fixed reference to a point. The navy uses angular measurements in clockwise degrees from 0 to 360. When 0 is referenced to true north, the result is a true azimuth bearing. When referenced to an arbitrary direction, such as the bow of a ship, the result is a relative azimuth bearing.

B

BATHYTHERMOGRAPH—Any device used to measure and record temperatures through a column of water.

BAUD—A measurement unit of electronic data transmission speed.

BT—Abbreviation for break transmission, used to indicate the beginning and end of a message body.

BULLETIN BOARD—A communications system that uses standard telephone lines to dial-in and access computer networks.

BYTE—A group of adjacent binary digits (bits).

C

CAD—Collective address designator.

CCTV—Closed-circuit television.

CHAFF—Material (such as strips of foil) ejected into the air in order to confuse enemy radar devices.

COMSEC—Communications security.

CONFIDENTIAL—Classified information that if disclosed could be expected to cause damage to national security.

COTS—Commercial-off-the-shelf.

CPU—Central processing unit of a computer.

CW—Continuous wave radio transmission.

D

DATA BASE—A collection of data organized for rapid search and retrieval by a computer.

DIFAX—Digital facsimile.

DMSP—Defense meteorological satellite program.

DPVS—Distributed plain language verification system.

DSN—Defense switched network, an upgrade and name change to the automatic voice network (AUTOVON).

DUCT—A layer in the atmosphere that readily traps electromagnetic energy permitting extended transmission ranges.

DUCTING—The process occurring within a duct, also known as trapping.

E

E-MAIL—Electronic mail.

ELECTROMAGNETIC SPECTRUM—The total range of the various radiation frequencies and corresponding wavelengths.

ELECTRO-OPTICS—General term used to describe weapons that make use of electromagnetic energy in order to function. These systems normally operate in the visible and infrared portions of the electromagnetic spectrum.

ESM—Electronic support measures. Radar surveillance conducted in passive mode designed to intercept hostile radar emissions.

F

FAA—Federal Aviation Administration.

FALLOUT—Radioactive particles resulting from a nuclear explosion and descending through the atmosphere.

FAX—Short form of facsimile, referring to weather facsimile or a telefacsimile transmission.

FLIB—Forward-looking infrared radar.

FMCR—Fleet multi-channel broadcast.

G

GCCS-M—Global command and communications system-maritime.

GFMP—Geophysics fleet mission program library.

Ghz—Gigahertz. One billion hertz or cycles per second.

GIGABYTE—A unit of information equal to one billion bytes.

GOTS—Government-off-the-shelf.

GWCS—Global weather communications system.

H

HECTOPASCAL (hPa)—A unit of 100 pascals used to measure pressure, exactly equivalent to 1 millibar.

HERTZ—A frequency defined as one cycle per second.

HF—High-frequency. Radio waves between 3 MHz to 30 MHz.

HOME PAGE—The first page or index of a particular website.

HTML—Hypertext Markup Language.

I

INFRARED (IR)—The portion of the electromagnetic spectrum with wave lengths just slightly longer than visible light energy (thermal energy).

INTERNET—A connection of several wide area networks. The Internet is also a term that is synonymous with the World Wide Web.

K

KILOBYTE—A unit of information equal to one thousand bytes. Also abbreviated as "KB".

KHz—Kilohertz. One thousand hertz or cycles per second.

L

LAN—Local area network.

LASER—Light amplification by stimulated emission of radiation, approximately equal to 1.06 microns.

LCD—Liquid crystal diode. A gray or black display of numbers or shapes commonly used in electronics.

LPM—Lines per minute. A setting used for HF radio weather facsimile transmissions.

LUF—Lowest usable frequency.

M

MANOP—Formatted weather message header that identifies the product type, originator, and area covered by the product.

MEGABYTE—A unit of information equal to one million bytes.

MET—U.S. Navy mobile environmental team.

METEOROLOGY—The study of phenomenon of /the atmosphere.

MHz—Megahertz. One million hertz or cycles per second.

METMF—U.S. Marine Corps meteorological mobile facility. Weather personnel who operate USMC Metvans.

MSI—Modified surf index. A single dimensionless number that is used to provide a relative measure of conditions likely to be encountered in a surf zone during amphibious operations.

MTF—Editor-Message text format. The AUTODIN message formatting software endorsed by the Navy.

MUF—Maximum usable frequency.

N

NATO—North Atlantic Treaty Organization.

NAVAID—An acronym for navigation aid, usually referring to an aircraft navigation aid.,

NAVMETOCOM—Short title for Naval Meteorology and Oceanography Command headquartered at the Stennis Space Center, Mississippi.

NAVOCEANO—Short title for the Naval Oceanographic Office, Stennis Space Center, MS. Also NAVO.

NEXRAD—Next generation radar. The weather surveillance radar-1988-Doppler (WSR-88D).

NIMA—National Imagery and Mapping Agency, headquartered in Washington, D.C.

NIPRNET—Nonsecure Internet protocol routing network used by the military.

NITES—Navy integrated tactical environmental system.

NOAA—National Oceanic and Atmospheric Administration, a division of the U.S. Department of Commerce.

NOTAM—Notice to airmen.

O

OA—Abbreviation for shipboard aviation operations division, the shipboard division for which most Aerographer's Mates work.

OAML—Oceanographic and atmospheric master library.

OMNI-DIRECTIONAL—An antenna capable of sending or receiving radio waves in all directions.

OTCIXS—Officer in tactical command information exchange system.

P

PASSIVE USW—A method for detecting submarines that evaluates a signal received by a hydrophone.

PLA—Plain language address used with AUTODIN messages.

PMSV—Pilot-to-meteorological service.

PSN—Processing sequence number used with AUTODIN messages.

R

RADFO—An acronym for radiological fallout.

RATT—Radio teletype.

REFRACTIVITY—The study of how electromagnetic energy is bent (refracted) as it moves through different density layers within the atmosphere.

S

SAR—Search and rescue.

SECRET—Classified information that if disclosed could cause serious damage to national security.

SERVER—A fast computer connected to the Internet full time. It directs Internet traffic to its proper destination.

SHF—Super-high frequency radio waves. Generally between 3 GHz and 30 GHz.

SIPRNET—Secure Internet protocol routing network used by the military.

SMOOS—Shipboard meteorological and oceanographic observation system.

SPECIAL-HANDLING MARKING—Designation applied to messages requiring special handling procedures. Special handling markings ensure messages so marked will be handled and viewed by authorized personnel only.

SSIC—Standard subject identification code.

STU-III—Secure telephone unit-third generation.

SYNOPTIC—In general, pertaining to or affording an overall view. In meteorology, this term has become specialized in referring to the use of meteorological data obtained simultaneously over a wide area for presenting a comprehensive picture of the state of the atmosphere.

T

TADIXS—Tactical data information exchange system.

TAF—Terminal Aerodrome Forecast.

TOP SECRET—Classified information that if disclosed could cause exceptionally grave damage to national security.

U

UHF—Ultra-high frequency radio transmission, generally between 300 MHz and 3 GHz.

URL—Uniform resource locator.

USMTF—United States message text format.

USW—Undersea warfare.

V

VALID—Effective, good.

VHF—Very-high frequency radio transmission, generally between 30 MHz and 300 MHz.

W

WAN—Wide area network.

WEBSITE—A collection of one or more web pages created by a person, company, or organization on the Web.

WEFAX—An acronym for weather facsimile, specifically the NWS service providing satellite imagery and graphic products via a geostationary satellite data broadcast.

WMO—World meteorological organization.

WORLD WIDE WEB—The large hypertext network of the Internet. Generally refers to the collection of websites on the Internet and the information that can be accessed from them.

WPM—Words per minute.

X

XBT—Expendable bathythermograph, usually referring to the probe that is dropped in the water and not recovered.

APPENDIX II

MANOP CODES

Environmental data messages use coded MANOP headings to facilitate the rapid automatic switching of the information at the AWN Automated Weather Data Switch (AWDS), as well as to provide recognition of the data contents. Refer to Chapter 1 of this module for a discussion on the format of MANOP headers.

TT- DATA CONTENT IDENTIFIERS

AB	Weather summaries; current conditions, previous day conditions, tropical weather summaries and outlooks, agricultural summaries, and agricultural advisories.	FB	Forecast, flight level winds/temps, navy altimeter setting, aviation area, public, prognostic discussions.
AC	Convective analysis.	FC	Terminal forecast valid 12 hours or less.
AN	Analysis of satellite imagery and radar observations.	FD	Forecasts; flight level wind/temp.
AR	Radar analysis.	FE	Forecasts, general surface, extended and outlooks; ice synopsis and outlook, upper air forecast and outlook.
AS	Analysis, surface level, pressure, fronts.	FJ	Forecasts, parcel trajectory.
AU	Analysis, constant pressure levels, heights, centers.	FK	Forecast, air pollution potential.
AW	Analysis, wind.	FM	Forecast, temperature extremes, special temperatures, convective gust potential.
AX	Analysis, miscellaneous: ice edge, satellite weather summaries, skew-t, terminal forecast receipt summaries, tropical cyclone, graphic analysis plots, analysis discussions, upper air, thickness analysis, flight hazards, snow depth, tropical weather summaries, observation receipt summary, alerts of significant tropical feature in satellite imagery, surface analysis, surface forecasts, upper-air observation receipt summary.	FN	Forecasts; general area weather (regional).
CA	Noncurrent scheduled TAF.	FO	Forecasts, Military: air routes, mission control, mission planning, operation area, air-refueling areas; paradrop zone, helo landing zone, SAR, High Interest Area upper winds/temps; Also, automated forecast guidance for military locations of MOS, NGM, LFM, and trajectory models (numerous parameters).
CB	Soil moisture.	FP	Public forecasts; general weather, coastal marine, lakes, mid-ocean; Special public forecasts; ozone, UV, lightning.
CM	Noncurrent scheduled METAR.	FQ	Height prog for standard isobaric levels.
CO	Monthly means (Oceanic).	FR	Forecasts, Air-routes.
CS	Monthly means (Surface).	FS	Forecasts, Surface coded: Pressure, temperatures, winds;
CT	Soil temperature reports.		Forecasts, 1000-hPa level.
CU	Monthly means (Upper-air).		
DF	Forecast, radiological fallout winds.		
FA	Forecast, aviation area weather (some with flight level winds/temps), aviation SAR weather.	FT	Forecast, Terminal Aerodrome (TAF) bulletins with valid periods of 12 hours or greater.

FU	Forecasts, Upper Air: Heights (IAC code), winds, temperatures, D-values, turbulence, vertical motion.	OS	Ocean surface, spectral sea data.
FX	Forecasts, Miscellaneous: any and every type of forecast-Specialized military operation forecasts, FNMOC Navy forecast support packages, forest fire forecasts, NBC nuclear EDFs and chemical CDFs, and forecaster discussions; Forecaster guidance bulletins, miscellaneous.	PD	Prognostic discussions (forecaster reasoning or model comparisons).
FY	Forecasts, Upper level temperatures, winds.	PL	Automated wind data.
FZ	Forecasts, Marine, SAR, small craft advisories; Forecaster guidance bulletins for marine shipping areas.	PW	WARNINGS, point weather (military).
GH	Gridded 500-hPa level forecasts.	RW	River report.
GP	Gridded surface analysis.	SA	Aviation hourly observations.
GT	Gridded upper-level temperature forecasts.	SE	Seismograph earthquake observations.
GW	Gridded upper-level wind forecasts.	SF	Atmospheric observations.
HE	Solar significant-event alerts.	SH	Ship synoptic report.
HF	Solar flux high frequency radio propagation conditions/forecasts.	SI	Synoptic surface observation, intermediate hours (3-hourly synoptic).
HI	Ionosphere observations.	SM	Synoptic surface observation, main hours (6-hourly synoptic)
HM	Geomagnetic (magnetometer) observations.	SN	Hourly synoptic report.
HO	Solar optical observations.	SO	BATHY observations.
HR	Solar radio-emission observations.	SP	Special (aviation hourly) observations.
HS	Solar observations from satellites.	SR	River stage and special service observations.
HX	Solar products, miscellaneous.	SS	Drifting buoy report.
IU	Geophysical alert, stratospheric alert.	ST	Ice report.
MM	Civil emergency warning.	SW	Supplementary aviation weather reports.
MS	Marine, combined wind wave/sea swell.	SX	Miscellaneous data.
MT	Marine, sea-surface temperature analysis.	TB	Satellite orbital prediction data
MV	Marine, sound channel data.	TC	Satellite tropical disturbance bulletin.
NO	Notices, weather circuit delays or changes, or product changes; Notices about temporary special support products; Notices, schedules, frequency changes.	TP	METSAT tropical storm position data.
OB	Oceanographic, beach surf-height forecasts (SURFCSTs).	TR	Satellite clear radiance data.
		TS	WMO satellite wind data.
		TU	Satellite vertical temperature soundings.
		TW	Satellite cloud motion derived wind data.
		TX	Data buoy position data.
		UA	Aircraft observations: PIREP, AIREP, AMDAR.
		UD	Maximum wind.
		UE	RAOB (part D).
		UF	RAOB (part C/D).
		UG	PIBAL (part B).
		UH	PIBAL (part C).

UI	PIBAL (part A/B).		WARNINGS, gale, storm, High Wind, small craft, harbor.
UJ	RAOB/PIBAL (all parts).		Bulletin, tropical disturbance status (U.S.)
UK	RAOB (part B).		Hazardous weather reports;.
UL	RAOB (part C).		Severe PIREPs, AIREPs;
UM	RAOB (part A/B).		Severe radar reports;
UN	Rocketsonde observations.		Special weather statements;
UP	PIBAL (part A).		Urgent specials.
UQ	PIBAL (part D).		
US	RAOB (part A).	WP	WARNINGS, and advisories for the public (Canada).
UT	Aircraft report.	WR	WARNINGS, flash flood.
UV	Wind vector difference.	WS	Flight advisories, SIGMETs.
UX	Upper Air, miscellaneous.	WT	WARNINGS, tropical cyclone.
UY	PIBAL (part C/D).	WU	WARNINGS, severe thunderstorm.
UZ	Dropsonde data.	WW	WARNINGS, Weather, general;
WA	Flight advisories, AIRMET/SIGMET.		Advisories, tropical disturbance (Australia);
WD	Tropical cyclone forecaster discussions;		WARNINGS, tropical cyclone (Indian Ocean, Bay of Bengal, Arabian Sea);
	Tropical cyclone advisories;		WARNINGS, gale, storm;
	Significant weather summaries.		WARNINGS, Tsunami (Japan);
WE	WARNINGS, Tsunami.		WARNINGS, point weather (Navy-Mediterranean);
WF	WARNINGS, Tornado and special marine.		WARNINGS, High Wind/High Sea;
WH	WARNINGS, Tropical Cyclone, including formation alerts;		WARNINGS, marine Sub-tropical cyclone;
	WARNINGS, High Winds.		Summary, destructive/severe weather reports;
	Forecast, Strike Probability.		WATCH, severe weather;
WM	WARNINGS, High Seas;		WARNINGS, severe weather;
	WARNINGS, Severe Weather (Indian Ocean);		Special weather statements;
	WARNINGS, Special Marine.		WARNINGS, (military) gale, small craft, gust.
WN	Nuclear bulletins.		
WO	WARNINGS, Severe Weather, High water, Marine shipping;	WX	WARNINGS, miscellaneous (military).
	WARNINGS, Marine, High Winds, high surf, high tide (storm surge), flooding, thunderstorm, tornado;	XN	Automated METAR.
		XT	Forecasts, military planning.
		YS	Worldwide METAR specials.

AA - GEOGRAPHICAL OR REGIONAL IDENTIFIERS

Most MANOP headings do not use specific country codes for products, but rather use regional identifiers. The following are the regional identifiers most frequently used in MANOP headings:

AA	Antarctica	JP	Japan
AC	Arctic Region	KA	Caroline Islands
AE	Southeast Asia	KO	South Korea
AF	Africa	LU	Aleutian Islands
AK	Alaska	MC	Central Mediterranean
AM	Central Africa	ME	Eastern Mediterranean
AO	West Africa	MM	Mediterranean
AP	Southern Africa	MV	Maldives
AR	Arabian Sea	MW	Western Mediterranean
AS	Asia	MX	Mexico
AU	Australia	MY	Marianas Islands
BN	Bahrain	NA	North America
BQ	Baltic Sea	NT	North Atlantic
CA	Caribbean	OC	Oceania
CI	China	OH	Sea of Okhotsk
CN	Canada	PA	Pacific
EA	East Africa	PE	Persian Gulf
EC	East China Sea	PH	Philippines
EE	Eastern Europe	PK	Pakistan
EM	Middle Europe	PN	North Pacific
EN	Northern Europe	PQ	Western North Pacific
EU	Europe	PS	South Pacific
EW	Western Europe	PW	Western Pacific
FE	Far East	PZ	Eastern Pacific
GA	Gulf of Alaska	RS	Russia (Europe)
GL	Greenland	SA	South America
GM	Guam	SD	Saudi Arabia
GX	Gulf of Mexico	SE	Southern Oceanic Area
HW	Hawaiian Islands	SJ	Sea of Japan
IO	Indian Ocean	SS	South China Sea

ST	South Atlantic	XS	Southern Hemisphere
UK	United Kingdom	XT	Tropical Belt
US	United States	XW	Western Hemisphere (between 0 and 180 degrees West)
XE	Eastern Hemisphere (between 0 and 180 degrees East)	XX	For use when other designations are not appropriate.
XN	Northern Hemisphere		

APPENDIX III

REFERENCES USED TO DEVELOP THE TRAMAN

NOTE: Although the following references were current when this TRAMAN was published, their continued currency cannot be assured. You therefore need to be sure you are studying the latest revision.

Chapter 1

Aeronautical Information Manual, U.S. Department of Transportation/Federal Aviation Administration, Washington, D.C., February 1998.

Allied Communications Publication, *Communications Instructions Radiotelephone Procedure*, ACP-125 (E), Joint Chiefs of Staff, Washington, D.C., August 1987.

Allied Communications Publication, *Communications Instructions Teletypewriter (Teleprinter) Procedures*, ACP 126 (C), Joint Chiefs of Staff, Washington, D.C., May 1989.

Automatic Digital Network (AUTODIN) Operating Procedures, JANAP 128 (J), Joint Chiefs of Staff, Washington, D.C., July 1993.

Configuration Management of Automated Information Systems, NAVMETOCCOMINST 5231.1, March 1996.

Department of the Navy Automatic Data Processing Security Program, OPNAVINST 5239.1 A, Office of the Chief of Naval Operations, Washington, D.C., August 1982.

Department of the Navy Information and Personnel Security Program Regulation, OPNAVINST 5510.1, Office of the Chief of Naval Operations, Washington, D.C., 1988.

DOD Flight Information Publication (Enroute), *IFR - Supplement United States (April 1998 edition)*, National Imagery and Mapping Agency, St. Louis, MO, 1998.

DSN User Services Guide, DISA Circular 310-225-1, Defense Information Systems Agency, Arlington, VA, April 1998.

Meteorology and Oceanography (METOC) Integrated Data Display System (MIDDS) User's Guide (version 2.1), Naval Oceanographic Office, Stennis Space Center, MS, June 1998.

Naval Telecommunications Procedure, *Telecommunications Users Manual*, NTP-3 (J), Naval Computer Telecommunications Command, Washington, D.C., July 1997.

NAVMETOCCOM Policy on Internet Access and Use of Government Information Systems, NAVMETOCCOMINST 5230.3, June 1998.

Networking Essentials, Microsoft Press, Redmond, WA, 1996.

Performance Specification for the Tactical Environmental Support System/Next Century TESS (NC) (NITES version I and II), Draft, Commander, Space and Naval Warfare Systems Command, San Diego, CA, December 1997.

Radioman Training Series, Module 4—Communications Hardware, NAVEDTRA 12848, Naval Education and Training Professional Development and Technology Center, Pensacola, FL., September 1997.

Radioman Training Series, Module 5—Communications Center Operations, NAVEDTRA 12849, Naval Education and Training Professional Development and Technology Center, Pensacola, FL, October 1997.

Secure Telephone Unit Third Generation (STU-III) COMSEC Material Management Manual, CMS 6, Director, Communications Security Material System, Washington, D.C., October 1990.

Steele, Heidi, *How to Use the Internet (third edition)*, New York, NY, 1996.

Supplemental Operator's Manual for Tactical Environmental Support System (TESS (3)), (Next Century (NC) Transition), SPAWAR EE685-HC-SUP-010, Commander, Space and Naval Warfare Systems Center, San Diego, June 1998.

Tactical Environmental Support System (TESS (3)) and Shipboard Meteorological and Oceanographic Observing System (SMOOS) Operator's Manual, Vol. IIA, NAVEXCEN VJO 14203-0302428A, NISE WEST, Vallejo, CA, 1993.

Tactical Environmental Support System (TESS (3)) and Shipboard Meteorological and Oceanographic Observing System (SMOOS) Operator's Manual, Vol. IIB, NAVEXCEN VJO 14203-0302428A, NISE WEST, Vallejo, CA, 1993.

Technical Manual Comparator-Converter Group AN/URA-17, AN/URA-17A, AN/URA-17B, Operation and Maintenance Instructions, SPAWAR EE162-JA-OMI-010/E110 URA17,A,B, Commander, Naval Space and Naval Warfare Systems Command, Washington D.C., 1983.

United States Navy Meteorological and Oceanographic Support Manual, NAVMETOCCOMINST 3140.1K, Commander, Naval Meteorology and Oceanography Command, Stennis Space Center, MS, September 1996.

Worldwide Marine Radiofacsimile Broadcast Schedules, (seventh edition), U.S. Department of Commerce/National Weather Service, Washington, D.C., March 1998.

Chapter 2

Advanced Refractive Effects Prediction System (AREPS) User's Manual (version 1.0), Technical Document 3028, Space and Naval Warfare Systems Center, April 1998.

Data Request Product (DRP) User Manual, FLENUMFTOCCEN Publication P-3146, September 1997.

Electra-Optical Tactical Decision Aid (EOTDA) User's Manual (version 3.1), PL-TR-94-2174 (I), Hughs STX Corporation, Lexington, MA, June 1994.

FNMOCC Products Manual, FLENUMETOCCEN Publication P-3140, October 1997.

Geophysics Fleet Mission Program Library New Technology (GFMP LN) User's Manual, Naval Oceanographic Office, Stennis Space Center, MS, July 1998.

Geophysics Fleet Mission Program Library (GFMPPL) Summary, Naval Oceanographic Office, Stennis Space Center, MS., February 1997.

Interim Mobile Oceanography Support System (IMOSS) User's Guide (DRAFT), Naval Oceanographic Office, Stennis Space Center, MS, December 1997.

Joint METOC Viewer User Manual, FLENUMETOCEN Publication P-352, November 1997.

Meteorology and Oceanography (METOC) Integrated Data Display System (MIDDS) User's Guide (version 2.1), Naval Oceanographic Office, Stennis Space Center, MS, June 1998.

Navy Oceanographic Data Distribution System (NODDS) Manual, FLENUMETOCEN Publication P-3147, May 1996.

Navy Oceanographic Data Distribution System Products Manual, FLENUMETOCOMINST 3147.1, February 1993.

Oceanographic and Atmospheric Master Library (OAML) Summary, Naval Oceanographic Office, Stennis Space Center, MS, April 1998.

Optimum Path Aircraft Routing System (OPARS) Manual FLENUMETOCEN Publication P-3710, February 1997.

Performance Specification (PS) for the Tactical Environmental Support System/Next Century TESS (NC) (NITES version I and II), Draft, Commander, Space and Naval Warfare Systems Command, San Diego, CA, December 1997.

Supplemental Operator's Manual for Tactical Environmental Support System (TESS (3)), (Next Century (NC) Transition), SPAWAR EE685-HC-SUP-010, Commander, Space and Naval Warfare Systems Center, San Diego, June 1998.

Tactical Environmental Support System (TESS (3.0)) and Shipboard Meteorological and Oceanographic Observing System (SMOOS) Operator's Manual, Vol. IIA, NAVELEXCEN VJO 14203-0302428A, NISE WEST, Vallejo, CA, 1993.

Tactical Environmental Support System (TESS (3.0)) and Shipboard Meteorological and Oceanographic Observing System (SMOOS) Operator's Manual, Vol. IIB, NAVELEXCEN VJO 14203-0302428A, NISE WEST, Vallejo, CA, 1993.

United States Navy Meteorological and Oceanographic Support Manual, NAVMETOCCOMINST 3140.1K, Commander, Naval Meteorology and Oceanography Command, Stennis Space Center, MS, September 1996.

Chapter 3

Department of the Navy Correspondence Manual, SECNAVINST 5216.5D, Department of the Navy, Washington, D.C., August 1996.

Department of the Navy Directives Issuance System, SECNAVINST 5215.1C, Office of the Chief of Naval Operations, Washington, D.C., April 1970.

Department of the Navy Directives Issuance System Consolidated Subject Index, OPNAVNOTE 5215, Office of the Chief of Naval Operations, Washington, D.C., February 1998.

Department of the Navy File Maintenance Procedures and Standard Subject Identification Codes (SSIC), SECNAVINST 5210.11D, Department of the Navy, Washington, D.C., October 1987.

Navy and Marine Corps Records Disposition Manual, SECNAVINST 5212.5D,
Department of the Navy, Washington, D.C., April 1998.

United States Navy Meteorological and Oceanographic Support Manual,
NAVMETOCOMINST 3140.1K, Commander, Naval Meteorology and
Oceanography Command, Stennis Space Center, MS, September 1996.

INDEX

A

Address indicator group, 1-22
Administration, general terminology, 3-1 to 3-2
Advanced Refractive Effects Prediction Program, 2-12
AFMEDS, 1-11 to 1-12
 equipment, 1-12
AIG, 1-22
Air Force Meteorological Data System, *see* AFMEDS
AN/SRA-12 antenna patch panel, 1-38
AN/UGC-143A(V) teleprinter, 1-44
AN/UGC-20 teleprinter, 1-42 to 1-43
AN/UGC-25 teleprinter, 1-44
AN/URA-17() comparator-converter, 1-40
AN/WRR-3() receiver, 1-38
Antenna, radio, 1-37 to 1-38
Antenna patch panel, AN/SRA-12, 1-38
AREPS, 2-12
AUTODIN, 1-2 1
 message formats, 1-21 to 1-22
Automated Surface Observing System (ASOS), 1-18 to 1-19
Automated Weather Network *see* AWN, 1-11,1-16
Automatic Digital Network, *see* AUTODIN
Automatic Response to Query (ARQ), 1-12
AWN, 1-11 to 1-13, 1-16
 AFMEDS, 1-12
 ARQ, 1-12
 MANOP headings, 1-12
 Message Format Transmitter (MFT), 1-12

B

Baud, 1-42
Baud rate, 1-42

Broadcast,
 facsimile, 1-35
 fleet multi-channel, 1-33 to 1-34
 HF, 1-37
 SHF, 1-33

Bulletin board systems, 1-9

C

CAD, 1-22
Change transmittals, 3-8 to 3-9
 processing of, 3-8 to 3-9
Charts,
 maintenance of, 3-11
Classification, markings, 1-1
Classification, message, 1-22
Classification, security categories, 1-1
CMW, 1-14
Collective address designator, 1-22
Commercial long-distance telephone, 1-3 to 1-4
Communications protocol programs, 1-6
Communications security, 1-1
Communications, telephone, 1-3 to 1-6
Comparator-converter, AN/URA-17(), 1-40 to 1-42
Computer flight plans, 2-18
Computer networks, 1-7 to 1-13
Contel Meteorological Workstation, 1-14
Converter, CV-483/URA-17, 1-40 to 1-42
CV-483/URA-17, converter, 1-40 to 1-42

D

Data Request Product, *see* DRP
Declassification instructions, message, 1-24
Defense Message System (DMS), 1-20
Defense Switched Network (DSN), 1-4
Digital facsimile (DIFAX), 1-13, 1-16

Directives,
 organization of, 3-2 to 3-4
 maintenance of, 3-7 to 3-8

Distributed Plain Language Address Verification System (DPVS), 1-22

DRP, 2-18 to 2-21
 BALW, 2-21
 BTXT, 2-20
 ENVR, 2-20
 GEM, 2-20
 JJPRO, 2-20 to 2-21
 PNTDT, 2-20
 RIBS, 2-20
 SAR, 2-20
 SNDFO, 2-21
 SPOUT, 2-20

DSN (Defense Switched Network), 1-4
 precedence, 1-4

DTG, message, 1-22

E

E-mail, 1-9 to 1-10

Electra-optics, 2-12 to 2-14

Electronic mail, 1-9 to 1-10

EO systems, 2-13

EOTDA, 2-12 to 2-14

F

Facsimile,
 Alden 9315 series TRT, 1-36 to 1-37
 Alden 9315 series TR4, 1-36
 HF broadcasts, 1-34 to 1-35
 recorders, 1-36
 recorder, telephone, 1-6

Fax, see facsimile

Files,
 maintenance of, 3-2 to 3-4, 3-7
 organization of, 3-2 to 3-4

Fleet multi-channel broadcast (FMCB), 1-33 to 1-34

Forms,
 maintenance of, 3-11

Free format message body, 1-24

Frequency range,
 ultra-high (UHF), 1-25
 very-high (VHF), 1-25

G

Gateguard, 1-20

GCCS-M, 1-30

Geophysics Fleet Mission Program Library (GFMPPL), 1-19

GFMPPL, 1-19, 2-3
 functions, 1-19, 2-4
 programs, 1-19, 2-4 to 2-5

Global Weather Communications System, 1-10

Global Weather Intercept Program, 1-10, 1-13

GWCS, 1-10

GWIP, 1-10, 1-13

H

High-frequency (HF) broadcasts, 1-34
 Coast Guard broadcasts, 1-35
 Foreign broadcasts, 1-35
 Navy fleet broadcasts, 1-35
 regional broadcasts (HFRB), 1-35

High frequency regional broadcasts (HFRB), 1-34 to 1-35

Homepage, 1-9

Hypertext link, 1-7

Hypertext Markup Language (HTML), 1-18

I

IMOSS,
 communications module, 1-32 to 1-33
 configuration, 1-31
 main module, 1-31 to 1-32
 satellite module, 1-33

IMOSS—Continued

Weather Fax, 1-33

WEATHERTRAC, 1-33

Instructions, 3-1

Integrated Refractive Effects Prediction System, 2-12

Interim Mobile Oceanographic Support System, *see*
IMOSS

Internet, 1-7 to 1-9

Internet service provider, 1-7

IREPS, 2-12

J

JMV, 1-13, 2-16

features, 2-16

products, 2-16

Joint METOC Viewer, *see* JMV

Joint Operations Tactical System (JOTS), 1-34

K

KSD-64A, 1-5

L

Local Area Network (LAN), 1-7

M

Message Format Transmitter (MFT), 1-19

Meteorology and Oceanography Integrated Data
Display System, *see* MIDDS

MIDDS, 1-14 to 1-19

ASOS communications link, 1-18 to 1-19

briefing support, 1-17 to 1-18

bulletin board access, 1-19

functions of, 1-14 to 1-19

GFMP application software, 1-19

Internet access, 1-19

receiver modules, 1-16

router modules, 1-15

weather group applications software, 1-16 to
1-17

Military networks,

NIPRNET, 1-8

SIPRNET, 1-9

Model 28 teleprinter, 1-42 to 1-44

Modems, 1-6

N

National Imagery and Mapping Agency (NIMA), 3-11

Naval message, 1-20

addressee, 1-2 1

address indicator group (AIG), 1-22

body, free format, 1-24

body, USMTF GENADMIN, 1-21 to 1-25

classification, 1-2 1

collective address designator (CAD), 1-22

Date/time group (DTG), 1-21

declassification, 1-21

DPVS, 1-22

format, AUTODIN, 1-20

format, GENADMIN, 1-22 to 1-25

format, USMTF, 1-20 to 1-21

formatting software, 1-20

gateguard, 1-20

header, 1-2 1

info addee, 1-21, 1-22

minimize, 1-25

originator, 1-21, 1-22

plain language address (PLA), 1-22

precedence, 1-21, 1-22

readdressal, 1-24 to 1-25

Standard Subject Identification Code (SSIC), 1-22

text separator, 1-21, 1-22

transmission ID, 1-21, 1-22

NAVCOMPARS, 1-45

Navy Integrated Tactical Environmental Subsystem,
see NITES

Navy Oceanographic Data Distribution System, *see*
NODDS

Navy standard teleprinter, 1-49

NIPRNET, 1-9

NITES, 1-30

NODDS, 1-9, 2-14 to 2-16
 processing and display features, 1-9, 2-15
 products, 1-9, 2-15

NOTAM, 1-10

Notices, 3-1

O

OAML,
 databases, 2-1 to 2-3
 models, 2-1 to 2-3

Oceanographic and Atmospheric Master Library, 2-1 to 2-3

OPARS, 2-17 to 2-18
 flight plan processing, 2-18
 MIDDS program, 2-18
 subsystems, 2-17 to 2-18

Optimum Path Aircraft Routing System, *see* OPARS

OTCIXS, 1-34

P

Permanent records, 3-4 to 3-5

Plain language address (PLA), message, 1-22

PMSV radio, 1-25 to 1-26
 communications protocol, 1-26 to 1-28
 prowords, 1-26 to 1-28

Publications,
 maintenance of, 3-10 to 3-11
 types of, 3-9 to 3-10

R

R-1051/URR receiver, 1-38

R-2368/URR receiver, 1-39

Radio,
 PMSV, 1-25 to 1-26
 terms, 1-27

Radio frequencies, 1-25

Radio, PMSV, 1-25 to 1-28

Radio receivers,
 AN/WRR-3(), 1-38
 R-1051/URR, 1-38 to 1-39
 R-2368/URR, 1-38 to 1-40
 switchboard SB-973/SRT, 1-40

RATT (radio teletype), 1-37

Receiver, *see* radio receiver

Records,
 disposal of, 3-6
 maintenance of, 3-6
 organization of, 3-2 to 3-4
 storage of, 3-6

Refractive effects prediction programs, 2-12

S

SB-973/SRT receiver switchboards, 1-40

Search engine, 1-9

Secure telephone unit, 1-5 to 1-6

Security clearance, 1-2

Security manual, 1-1

Server, 1-7

SHF, 1-33

Shipboard antenna, 1-37 to 1-38

Shipboard communications, 1-37 to 1-46

Shipboard radio receivers, 1-38 to 1-40
 RATT broadcast, 1-37
 voice broadcast, 1-37

Shipboard teleprinters, 1-42 to 1-46

SIPRNET, 1-9

SMOOS, 2-6

Special-handling markings, 1-1 to 1-2

Standard Subject Identification Code (SSIC), 3-2

STU-III, *see* secure telephone unit

T

Tactical Environmental Support System (TESS), 2-5 to 2-12

TADIXS, 1-39

Telefax, 1-6

Telecommunications systems, 1-3 to 1-13

Telephone systems, 1-3 to 1-6

- commercial long-distance, 1-3 to 1-4

- communications, 1-3 to 1-6

- defense switched network, 1-4 to 1-5

- equipment, 1-5 to 1-6

- modems, 1-6

- secure, 1-5 to 1-6

- system access, 1-3

Teleprinter terminals,

- AN/UGC-143A, 1-42

- AN/UGC-20, 1-42 to 1-44

- AN/UGC-25, 1-42 to 1-45

- model 28, 1-42 to 1-45

- Navy standard, 1-44

- TT-48/UG, 1-42 to 1-43

- TT-69/UG, 1-42 to 1-44

TESS (3), 1-28 to 1-30

- hardware configuration, 1-29, 2-6 to 2-11

- software programs, 1-29 to 1-40, 2-6 to 2-11

TESS-NC,

- hardware configuration, 1-30

- software programs, 1-30, 2-11

TESS-NC Transition,

- hardware configuration, 1-29

- software programs, 1-29 to 1-30, 2-11 to 2-12

Transmission ID, message, 1-22

TT-48/-UG, 1-42 to 1-43

TT-69/UG, 1-42 to 1-44

U

Ultra-high-frequency (UHF), 1-25

Uniform Resource Locator (URL), 1-9

USMTF GENADMIN message body, 1-22 to 1-25

V

Very-high-frequency (VHF), 1-25

W

Weather communications networks, 1-10 to 1-13

- Global Weather Intercept Program (GWIP), 1-10

- Automated Weather Network (AWN), 1-11 to 1-12

Web browser, 1-9

Website, 1-9, 1-11

- METOC-related, 1-9, 1-11

Wide Area Network (WAN), 1-7

World Wide Web (WWW), 1-7 to 1-8

Assignment Questions

Information: The text pages that you are to study are provided at the beginning of the assignment questions.

ASSIGNMENT 1

Textbook Assignment: "Environmental Communications," "Environmental Software Programs," and "Administration", chapters 1, 2, and 3, pages 1-1 through 3-11.

- 1-1. What publication governs security procedures for the United States Navy?
1. OPNAVINST 5510.1
 2. NTP3
 3. SECNAVINST 5210.11
 4. NAVMETOCCOM Security Manual
- 1-2. Which of the following special-handling markings is used to identify unclassified material that must not be released to the public?
1. NOFORN
 2. LIMDUS
 3. FOUO
 4. WNINTEL
- 1-3. The Defense Switched Network (DSN) is not a secure telephone system.
1. True
 2. False
- 1-4. In which of the following situations may classified information be discussed over a STU-III telephone?
1. Whenever connected to any other telephone
 2. When connected to another STU-III unit only
 3. Only when used on the DSN network
 4. Only when using the Secure Telephone Network
- 1-5. When carried on mobile operations, what component of the STU-III system must be left in secure storage at the home base?
1. STU-III terminal
 2. STU-III modem
 3. Seed key
 4. CIK key
- 1-6. Which of the following terms describes computer hubs that direct Internet traffic to its proper destination?
1. LANs
 2. Links
 3. Websites
 4. Servers
- 1-7. Which of the following terms is used to describe commercial software designed to directly access websites using a URL?
1. Web browser
 2. Search engine
 3. World Wide Web
 4. Protocol
- 1-8. Which of the following networks represents the military's unclassified Internet routing network?
1. Wide Area Network
 2. NIPRNET
 3. SIPRNET
 4. World Wide Web

- 1-9. What information must be included in an e-mail address?
1. User name and host name of destination computer
 2. Host name of destination computer only
 3. Internet protocol type
 4. User name and homepage of the destination website
- 1-10. Which agency is responsible for coordinating and validating Navy and Marine Corps AWN data requirements?
1. NAVO
 2. FNMOC Monterey
 3. FNMOD Tinker
 4. CNMOC
- 1-11. In the symbolic format of a MANOP header, what letters identify the geographical area covered by the information in the product?
1. First two of first group: TT
 2. Second two of first group: AA
 3. All four in second group: CCCC
 4. First two of third group: YY
- 1-12. Which of the following AWN messages contain items of interest to aviators, such as temporary runway closures?
1. TBUS
 2. ARQ
 3. AXXX
 4. NOTAMS
- 1-13. Which of the following functions is NOT provided with MIDDS?
1. A briefing station
 2. A METOC products distribution station
 3. an environmental workstation
 4. A tactical workstation
- 1-14. The MIDDS Dial RX Receiver module is used primarily to receive what type of product?
1. Radar images
 2. NWS forecast bulletins
 3. AWN data
 4. Mercator projection maps
- 1-15. The SAND application in MIDDS is used to display what type(s) of information?
1. AWN data
 2. ASOS data
 3. Satellite and radar images
 4. Briefing slides
- 1-16. What MIDDS application software tool can provide temperature trend graphs for your station?
1. ASOS communications link
 2. Briefing Support
 3. SAND
 4. FOS
- 1-17. Which of the following systems acts as a security screen for incoming and outgoing AUTODIN messages?
1. NAVCOMPARS
 2. Defense Message System (DMS)
 3. Gateguard
 4. Global Command and Control System (GCCS)
- 1-18. Message Text Format (MTF) editor is the message formatting software used by the Navy.
1. True
 2. False

- 1-19. What publication provides instructions for completing USMTF formatted messages and free form messages?
1. OPNAVINST 5510.1
 2. JANAP 128
 3. NWP 1-03.1
 4. NTP-3
- 1-20. For transmission via AUTODIN, which of the following message types must follow USMTF GENADMIN guidelines?
1. LOGREQs
 2. MOVREP s
 3. Casualty reports
 4. General administrative messages
- 1-21. In the message precedence and date-time group 0 271135Z APR 99, what is the precedence?
1. Routine
 2. Priority
 3. Immediate
 4. Flash
- 1-22. OCEANO EAST is an example of a/an
1. AIG
 2. PLA
 3. ALCOM
 4. CAD
- 1-23. When, if ever, must a narrative line be included in a GENADMIN message?
1. Every time a reference is used
 2. Every time two or more references are used
 3. Only after a reference that is also a reference in another GENADMIN message
 4. Never, because the use of a narrative line is strictly optional
- 1-24. Which of the following meteorological conditions would automatically exempt a weather observation from MINIMIZE?
1. Maximum observed wind speed in the last 6 hours was 32 knots
 2. Light snow is occurring
 3. The average swell wave height is 12 feet at the time of observation
 4. Visibility has decreased to 1 3/4 mile in the last hour
- 1-25. You are manning the PMSV radio. A pilot calls and asks for the current observation at a different station. You need 30 to 40 seconds to retrieve that information. What should your reply be to the pilot?
1. STANDBY, OVER
 2. ROGER, WAIT, OUT
 3. WILCO
 4. ROGER, OUT
- 1-26. What type of information must NOT be relayed over the PMSV radio?
1. U.S. Navy ship positions
 2. U.S. Navy ship TAFs
 3. Military airfield call signs
 4. Military aircraft call signs
- 1-27. What is the main function of TESS?
1. To evaluate the accuracy of scientific environmental models
 2. To assess the threat characteristics of hostile platforms
 3. To access dedicated METOC telecommunications channels
 4. To assess the effects of the environment on fleet platforms, weapons, and sensors

- 1-28. What is the major difference between TESS-NC Transition and older versions of TESS?
1. The introduction of shock-isolated equipment cabinets
 2. Internet access
 3. Direct interface with the SMQ-11 satellite receiver
 4. Ingest capability for SMOOS data
- 1-29. NITES I is a designation of which of the following systems?
1. TESS-NC
 2. MIDDs
 3. IMOSS
 4. TESS-NC Transition
- 1-30. The software segment of the Global Command and Control System-Maritime (GCCM-M) is part of what NITES subsystem?
1. NITES I
 2. NITES II
 3. NITES III
 4. NITES IV
- 1-31. The IMOSS system is designed for what segment of METOC support?
1. Afloat OA divisions
 2. NAVMETOCCOM activities overseas
 3. MET members and METMF members
 4. METOC regional centers
- 1-32. What is the primary function of the IMOSS communications module?
1. Copy alphanumeric data and weather facsimile data
 2. Copy APT and WEFAX satellite imagery
 3. Run GFMPPL software
 4. Process AUTODIN messages
- 1-33. Environmental data from the AWN system is forwarded to naval ships as part of a secure communications system known as
1. AUTODIN
 2. MET ASSIST
 3. AFMEDS
 4. FMCB
- 1-34. Which NAVMETOC regional center is responsible for maintaining the Sixth Fleet Environmental Broadcast?
1. NPMOC West Guam
 2. NPMOC Pearl Harbor
 3. NLMOC Norfolk
 4. NEMOC Rota
- 1-35. What organization maintains an HF facsimile broadcast of National Weather Service charts?
1. U.S. Air Force
 2. U.S. Coast Guard
 3. Department of Defense
 4. Department of Commerce
- 1-36. Which of the following publications is most useful for obtaining meteorological broadcast radio frequencies?
1. NAVMETOCCOMINST 3140.1
 2. Worldwide Marine Radiofacsimile Broadcast Schedules
 3. Facsimile Products Catalog
 4. Weather Message Index
- 1-37. If your TR4 minifax recorder is producing skewed images, what must you do to correct the problem?
1. Replace the preamplifier
 2. Reink the thermal print head
 3. Adjust the Lines Per Minute (LPM) setting
 4. Adjust the stylus belt

- 1-38. What radio receiver is the replacement for the R-1051/URR series radios?
1. AN/WRR-3
 2. R-390/URR
 3. R-2368/URR
 4. R-3500/URR
- 1-39. If the "X" patterns in the CRT window of a CV-483 is shifted below the inscribed guidelines, what must you do to optimize the signal?
1. Frequency should be lowered
 2. Frequency should be raised
 3. Signal level should be decreased
 4. Signal level should be increased
- 1-40. What models of the AN/UGC-143 Navy Standard Teleprinter (NST) are equipped with a bulk storage module?
1. RO2 and ASR
 2. RO1 and RO2
 3. ASR and KSR
 4. ASR only
- 1-41. What agency is responsible for maintaining the OAML models and data bases?
1. NAVO Stennis Space Center
 2. FNMOC Monterey
 3. FNMOD Asheville
 4. NAVICE Suitland
- 1-42. What is GF MPL?
1. A collection of atmospheric and oceanographic software applications
 2. A program sponsored by Commander, Naval Meteorology and Oceanography Command
 3. A program to collect, evaluate, and incorporate new software applications
 4. All of the above
- 1-43. The analyses and predictions of GF MPL are based upon which of the following sources?
1. On-scene data
 2. Historical data
 3. Both 1 and 2 above
 4. AUTODIN message
- 1-44. Which of the following GF MPL programs produces horizontal contours of ocean temperature, sound speed, and salinity?
1. NAVSAR
 2. B S C
 3. G A P
 4. SURF
- IN ANSWERING QUESTIONS 1-45 THROUGH 1-47, REFER TO TABLE 2-3 IN THE TRAMAN. THIS TABLE REPRESENTS TESS (3) ENVIRONMENTAL PROGRAMS.
- 1-45. What TESS (3) environmental program is used to compute ballistic wind and density correction values for naval gunfire support?
1. ARPGEN
 2. RIA
 3. BALWIN
 4. SOCUS
- 1-46. What TESS (3) environmental program provides the capability to determine how an EM system will perform while detecting or communicating with a given target or receiver?
1. RADFO
 2. ODA
 3. COVER
 4. LOSS

1-47. What TESS (3) environmental program calculates sound transmission loss as a function of range, frequency, source depth, and receiver depth?

1. PPL
2. ODA
3. BGV
4. PCS

1-48. Commercial web browsers are included with the TESS-Next Century suite of software?

1. True
2. False

1-49. Which software program in TESS-Next Century is used to produce sound speed profiles, acoustic raytraces, and passive acoustic propagation loss displays?

1. SMOOS
2. EOTDA
3. SAND
4. SIIP

1-50. Refraction effects prediction programs are designed for what purpose?

1. Performance assessment of sonar systems
2. Performance assessment of radar systems
3. Performance assessment of electro-optical systems
4. Performance assessment of hazard avoidance systems

1-51. What is the most significant advantage of AREPS over IREPS?

1. AREPS has a faster run time
2. AREPS can be used for refractive predictions over land
3. AREPS can be used in conjunction with satellite data
4. AREPS can compute ranges for multiple bearings at one time

1-52. The EOTDA program supports systems operating in what portion(s) of the electromagnetic spectrum?

1. X-ray and ultraviolet
2. Visible and infrared
3. Radio only
4. Radio and microwave

1-53. What type of satellite imagery can be retrieved from NODDS?

1. GOES 8 and 9
2. METEOSAT and GOES
3. DMSP
4. TIROS N

1-54. How many data fields can be downloaded onto a single NODDS chart?

1. One
2. Three
3. Five
4. Seven

1-55. Products from the Joint METOC Viewer (JMV) are obtained via what method?

1. Commercial telephone
2. Satellite broadcast
3. HF facsimile broadcast
4. Internet

1-56. Joint METOC Viewer (JMC) products are disseminated by which of the following activities?

1. NAVMETOC regional centers and FNMOC Monterey
2. FNMOC only
3. Air Force Weather Agency (AFWA)
4. National Weather Service (NWS)

- 1-57. The Optimum Path Aircraft Routing System (OPARS) selects the best route and altitude for an aircraft to reach a destination.
1. True
 2. False
- 1-58. Within the OPARS system, where can information on aircraft performance characteristics be found?
1. Communications interface
 2. Flight planner/environmental data base
 3. OPARS data base
 4. NOGAPS data
- 1-59. How often are updates to the OPARS data base released?
1. Every 7 days
 2. Every 28 days
 3. Quarterly
 4. Semiannually
- 1-60. A commonly used OPARS air route that is saved for future use is known by what term?
1. Predefined route
 2. Jet-route
 3. Multi-use route
 4. Canned route
- 1-61. Which of the following DRP products provides an alphanumeric BT/SVP profile for a specific location and also includes several other oceanographic parameters?
1. ENVR
 2. SNDFO
 3. BTXT
 4. BALW
- 1-62. The SPOUT product provides what type of information?
1. Satellite imagery
 2. Tropical cyclone evasion recommendations
 3. Hourly observation reports
 4. Acoustic propagation loss data
- 1-63. Which term describes a directive that can remain in effect for a maximum of one year?
1. Record
 2. Instruction
 3. Notice
 4. Change transmittal
- 1-64. Which term is defined as evidence of a government agency's function, organization, procedures, and operations?
1. Record
 2. Instruction
 3. Notice
 4. Change transmittal
- 1-65. Which term describes a directive that remains in effect until superseded or canceled?
1. Record
 2. Instruction
 3. Notice
 4. Change of transmittal
- 1-66. Which term describes a directive that is used to correct, update, or modify an existing product?
1. Record
 2. Instruction
 3. Notice
 4. Change transmittal

- 1-67. An instruction that contains information on general administration would be filed using which of the following SSIC major-subject code groups?
1. 1100 to 1974
 2. 3000 to 3999
 3. 5000 to 5999
 4. 9212 to 9800
- 1-68. Which of the following directives provides a listing of effective Naval Meteorology and Oceanography Command instructions?
1. SECNAVINST 5210.11
 2. NAVMETOCCOMINST 5215
 3. NAVMETOCCOMINST 3142.1
 4. OPNAVNOTE 5215
- 1-69. Which of the following records would be classified as temporary?
1. Upper air observations
 2. Training reports
 3. Bathythermograph observations
 4. MET trip reports
- 1-70. What term refers to the period of time that information must be kept available for reference before being destroyed or transferred?
1. Cut-off date
 2. Retention period
 3. Disposal date
 4. Transfer period
- 1-71. What would be the cut-off date for a file containing budgetary information?
1. December 31
 2. January 01
 3. September 30
 4. October 01
- 1-72. What is the first task you must complete when assigned to maintain command files?
1. Establish all new files
 2. Destroy all temporary material
 3. Arrange all file folders in SSIC order
 4. Inventory all current files
- 1-73. Unless specifically stated, which of the following change transmittal types would not actually be made throughout the instruction?
1. Repetitive changes
 2. Pen changes
 3. Paste-in changes
 4. Page changes
- 1-74. Which of the following publications or directives identifies required publications for various Naval Meteorology and Oceanography Command activities?
1. Master Publications Allowance List
 2. NAVMETOCCOMINST 3140.1
 3. NAVOCEANO RP-50
 4. OPNAVNOTE 5215
- 1-75. Which of the following activities is the best place to obtain climatological information?
1. FNMOC Monterey
 2. Naval Oceanographic Office
 3. Federal Records Center
 4. FNMOD Asheville

